

DIN Panel Instrument Cases

1/8 DIN 96 x 48 x 110 mm - IC-148

DIN Panel Cases are suitable for Panel Flush mounting Analog - Digital Instruments / Man-machine interface equipment / process indicators and controllers like Temp indicator, controller, Timers, Counters etc Case is available with front loading cassette which offers space for mounting electronic inside and provides display facility in front and connectors at back. Cassette is versatile assembly of plastic Front and Back panel plate which are joined together by metal plates or PCBs. The plastic Front Plates are also available with few standard cut outs. Back plates are available in plain or with Terminal of solder able type or PCB insertion type.

IC-148

Features

- Case size 96x48x 110 mm
- Dimensional size per DIN 43 700 - Panel flush mounting.
- Panel Mounting -- Case inserted into the cutout of the control panel from front and fastening clamps are fixed from rear.
- Front loading cassette offers electronic mounting facility.
- Cassette: versatile assembly of front plate, back plate, Metal plate and PCBs.
- Front plate available in plain / with Std. cut out & display sheet.
- Back plate in plain / with integral moulded terminals.
- Terminals: 8 wire solder type / PCB insertion type.
- Customization : Cutout / holes in front plate possible

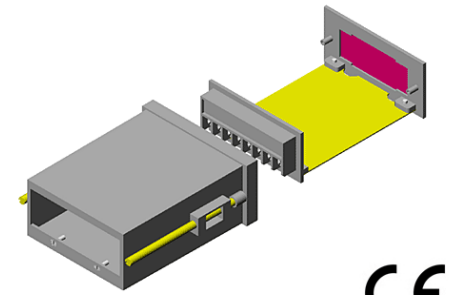

Case Parts

- | | |
|--------------------------------------|--|
| 1. Case | 7. Back plate wire jumper C type Term. |
| 2. Clamp | 8. Back plate PCB insertion D type Term. |
| 3. Front plate plain | 9. Metal plate |
| 4. Front plate Type 01 | 10. Horizontal PCB |
| 5. Back plate plain | 11. Red acrylic |
| 6. Back plate with add on GT-1 Term. | 12. Screws |

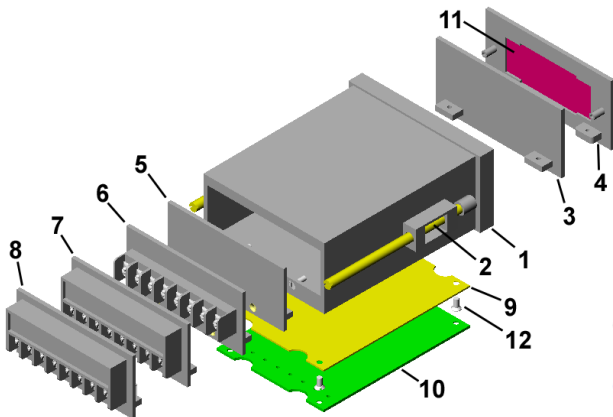

Material :

Case : ABS **Front / Back plain plates :** ABS

Back plates : Nylon

Color : Gloss Black

Matt Finish Spray painted Black & Dark Gray

Cassette Standard Kit

A type

Front Plate plain + Back plate plain + Metal plate + two Angles + Screws

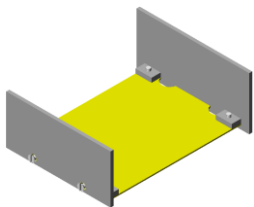

B type

Front Plate plain + Back plate plain + Gt-1 Add on Term + Metal plate + two Angles + Screws

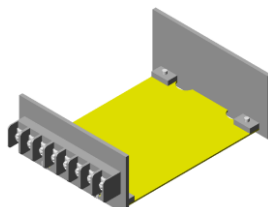

C type

Front Plate with display cut out + Back plate with integral wire jumper Term. + Metal plate + two Angles + Screws

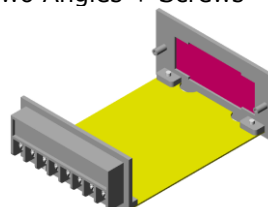

D type

Front Plate with display cut out + Back plate with integral PCB insertion Term. + Screws

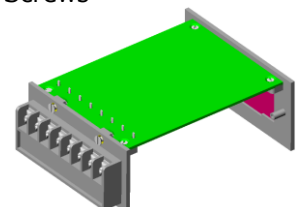

New Development: Back Plate for Euro Terminal Max. 15

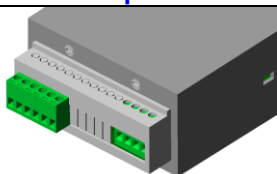

Back Plate for Euro Terminal 5mm pitch Max 15 Term. Fixed OR Plug-In Term. Terminals mounted directly on Horizontal PCB with other components reducing process and bring more reliability.

New Development: Terminal protection Cover

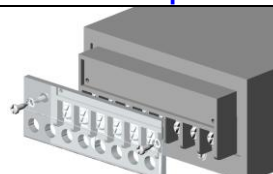

TC-48 - Transparent terminal cover fixed on Back Plate C & D Type offers protection against accidental contact. IP20 (finger protected). It has recess for Terminal configuration diagram sticker.

Ordering Information

IC-148-01	Case in Black gloss Color
IC-148-02	Case + Clamps
IC-148-03	Case + Clamps + Cassette 'A' type (FP, BP plain & Metal plate)
IC-148-04	Case + Clamps + Cassette 'B' type (FP, BP with 8 GT-1 Term, & Metal plate)
IC-148-05	Case + Clamps + Cassette 'C' type (FP with display cutout, BP with integral 'C' - Wire Jumper Max 8Term & Metal plate)
IC-148-06	Case + Clamps + Cassette 'D' type (FP with display cutout, BP with integral 'D' - PCB Insertion Max 8Term)
IC-148-07	Case + Clamps + Cassette 'E' type (FP Plain with Back Plate for Euro Terminal 5mm pitch Max 15 Term. Fixed OR Plug-In Term.
ACCESSORIES (Loose Parts)	
ICCL-100	Clamps 100mm Long for IC-110,150,148,048,072
FP-48-00	Front Plate Plain for 96x48 case in A & B Type Cassette
BP-48-00	Back Plate Plain for 96x48 case in A & B Type Cassette
FP-48-01	Front Plate With Display Cut out Type - 01
BP-48-01	Back Plate for integral 'C' & 'D' type term, w/o Term. Connectors
BP-48-02	Back Plate for Euro Terminal 5mm pitch Max 15 Term. Fixed OR Plug-In Term.
MPL - 110	Metal Plate for 110 mm depth Case in IC-110/148
RTS-96-01	Red Transparent Sheet for FP-48-01
TC-C	Term. Connectors C Type Loose
TC-D	Term. Connectors D Type Loose
DCT	Dust Cover for Term. Replacement in B.P.
GT-1	Term. Add On Type for B Type Connection per way
GT-1Pcb	PCB for GT-1 Term. Mounting per way available for 2 to 8 ways
TC-48	Terminal Transparent Protection Cover for 96 x 48 cases

Detail Drawing

