

Operating Instructions

Combined Melt Pressure / Temperature with switching output

DTAIL

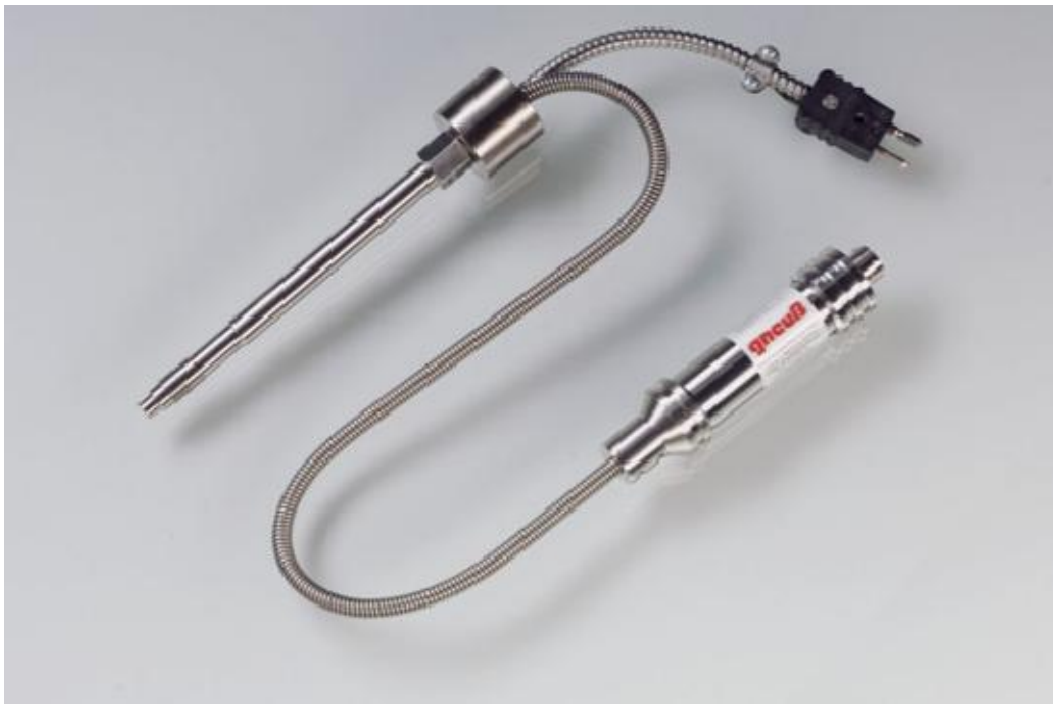

Certified to
ISO 9001

Please read this instruction manual carefully before installing the transducer.

Contents:

1. Introduction
2. Operating range and field of application
3. Danger areas
4. Waste disposal
5. Transport and storage
6. Cleaning of the sensors
7. Installing / Uninstalling
8. Switching output for pressure monitoring
9. Connecting and commissioning of the DAIL
10. Technical data
11. Dimensions

1. Introduction:

Melt pressure transducers are precise measuring probes which obtain their measuring accuracy and long life span only if they are properly handled. These operating instructions should be studied carefully before installing the sensor, thus ensuring a trouble-free operation. Nevertheless, should you encounter any difficulties, please feel free to contact our technicians or our representatives, who will be pleased to be of assistance.

2. Operating range and field of application:

Gneuss melt pressure transducers with switching output have exclusively been designed for pressure measurement and monitoring of liquid, doughy or pasty materials at high temperatures. These must have a homogeneous constitution.

The transducer's use as safety-relevant component only refers to the preset limit value + switching output. If used for pressure monitoring of a machine part according to section 5.2.5 of EN 1114-1, the analogue measuring channel must not be used for pressure control of this component at the same time.

The application area has to be selected in such a manner, that a max. differential pressure of 2 % of the measuring range – based on the diaphragm surface - is not exceeded.

The temperature of the measuring tip and the electronics during running operation may not exceed the values given in the technical data. Even a short-term exceeding of the admissible operating temperature can impair the safety function of the sensor. In this case, the unit must be checked by Gneuss Kunststofftechnik GmbH.

Any use beyond the above mentioned application area does not conform to regulations.

3. Danger areas:

In the complete application area of the melt pressure transducer, there is a risk of combustion. If the pressure transducer is not installed or uninstalled correctly during the applying of pressure there is a risk of hot media emerging.

4. Waste disposal:

Pressure transducers filled with mercury, have to be disposed of as hazardous waste. A free of charge and ecologically-friendly disposal can be carried out by Gneuss Kunststofftechnik GmbH.

5. Transport and storage:

Gneuss pressure transducers are generally dispatched in separate packages. In case of mechanical exposure, the sensing diaphragm is protected by a cap. This cap should be screwed on at all times of storage.

6. Cleaning of the sensors:

In order to clean the diaphragm, the sealing surface and the process thread the sensor must have the same temperature as the plastic melting point. The diaphragm and the sealing surface can be wiped down with a soft cloth, the thread can be cleaned with a steel brush.

(Do not come into contact with the diaphragm surface!)

7. Installing / Uninstalling:

Installing

On installation of the pressure transducer it is imperative to note that the sensor bore corresponds to the dimensions mentioned below. The fitting accuracy can be checked by means of a test bolt.

Prior to mounting the sensor, the thread should be covered with a heat resistant paste.

Should the machinery with the sensor drilling still be at production temperature, a certain preheating period for the sensor should be taken into consideration, in order to avoid a seizing of the sensor due to thermal expansion.

On mounting the transducer, it is important that the sensor is not screwed in at an angle and that the sensor does not fall into the bore. It is of vital importance that the force for installing the sensor must only be applied at the shaft (hexagon). Do not apply any force to the sensor head!

Starting torque for 1/2-20 UNF = max. 30 Nm

Starting torque for M 18 x 1,5 = max. 50 Nm

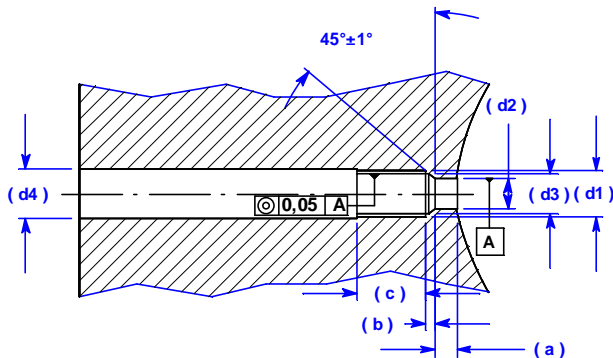

d1	M18x1,5	1/2"20UNF 2A
d2	Ø 10,1 ^{+0,05}	Ø 7,9 ^{+0,05}
d3	Ø 16,1 ^{+0,1}	Ø 10,7 ^{+0,1}
d4	Ø 20 ^{+0,2}	Ø 13 ^{+0,2}
a	6,1 ^{-0,1}	5,7 ^{-0,1}
b	4 ^{-0,2}	3,2 ^{-0,2}
c	25	19

Dimensions of the mounting hole

Uninstalling

The uninstalling of the pressure transducer has to be done in a heated up condition (plastic melting point). On removal of the sensor, please take note that the diaphragm is not brought into contact with surrounding parts. It is of vital importance that the force for uninstalling the sensor must only be applied at the shaft (hexagon). Do not apply any force to the sensor head!

The most common cause of failure of this kind of pressure transducers is the damage of the diaphragm during installing/uninstalling of the transducer. Even minor damage to the diaphragm can impair the transducer's function. In case of visible damage of the diaphragm, the transducer must be checked by Gneuss Kunststofftechnik GmbH prior to any further use.

8. Switching output for pressure monitoring:

The switching function of the transducer complies with Performance Level C (PL `c`) in accordance with EN13849-1. It can therefore be used, if integrated accordingly into the machine control, for protection against overpressure in extrusion lines (according to EN1114-1). The switching output is closed as long as the pressure is not exceeded ("good" state) and opens in case of:

- exceeding the preset pressure limit value
- interruption of the power supply
- interruption or short-circuit of part of the measuring element
- power supply failure of the measuring element.

The switching function must be checked regularly, at least once a year, and the transducer must be checked for wear of all parts in contact with the melt, for mechanical damage and with regard to its measuring accuracy. We recommend that these points must be checked by Gneuss Kunststofftechnik GmbH.

When integrating the switching output into the machine control, the following points are of vital importance:

- We recommend to limit the maximum current of the switching output by means of a semi-conductor fuse to 500 mA.
- In addition, the semi-conductor switching output has an internal short-circuit protection.
- The machine control must avoid an automatic restart of the pressure-generating components after having fallen below the switching threshold. The switching output of the transducer has no memory function.
- If using the safety output for monitoring of a maximum pressure, the analogue output signal may be used for pressure display, but not for pressure control by the machine control of the component to be protected.

9. Connections and commissioning:

After the pressure transducer has been installed into the line, as described in section 7, the electrical connections have to be applied according to the connections described hereafter. Gneuss pressure transducers are equipped with high quality and robust plug connections. The connecting wire should be soldered with great care as transmission errors of signals can otherwise occur. We recommend using Gneuss prefabricated connecting wires which are available ex-stock.

Pressure sensors of the type DTAIL are fitted with an integrated measurement amplifier, which depending on version can offer a standard signal in accordance with the pressure range. On commissioning, the sensor must be calibrated to the corresponding evaluation unit. **The calibration process must be carried out when the line is heated and at zero pressure.** Please proceed as described below.

After successful installation and thorough heating of the pressure sensor, the zero point must be adjusted by activating the **AUTO ZERO** function.

The **AUTO ZERO** function is initiated by a short connection of the corresponding wires (see wiring configuration). For the DAI version with optical **AUTO ZERO** initiation (DAI-...-6PA) the zero point calibration can be initiated directly at the sensor. For this, remove the screw plug near the connecting plug and direct the beam of an LED flashlight into this opening for approx. 3-5 seconds.

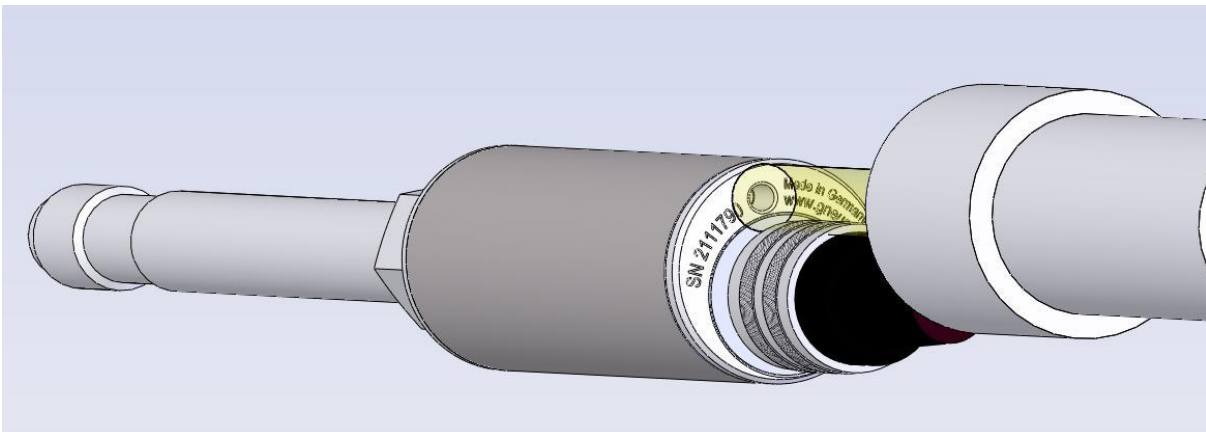

Insert the screw plug again afterwards; it simply serves for protection against contamination and extraneous light. The protection class is not impaired even without the screw plug being fitted.

The integrated amplifier will thereafter transmit the starting value of its output scale (0V at 0...10V, 0mA at 0...20mA and 4mA at 4...20mA output signal). The **AUTO ZERO** function is suppressed, if the output signal is more than 5 % of the maximum value.

Afterwards an 80% inspection of the output signal can be performed. All corresponding lead wires need to be connected for this procedure (see wiring diagram). The pressure sensor will now supply a signal which is according to 80% of the measuring value.

Electrical wiring configuration **3-wire sensor**

connector type: **8P** (PC06A-12-8P)

0/4...20mA
0...10V

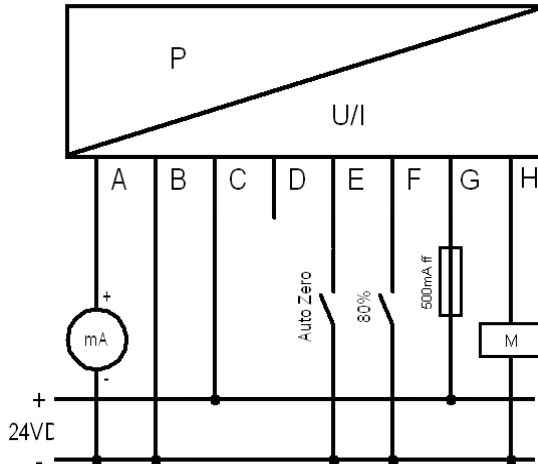
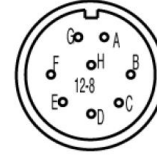

Pin	Function	Colour coding (Gneuss cable)
A	Signal +	Yellow
B	Supply / Signal -	White
C	Supply +	Brown
D	free	Green
E	Auto Zero	Pink
F	80%	Grey
G	Switching output	Red
H	Switching output	Blue

In order for the Auto-Zero function to be activated, pin E and supply – have to be connected with each other. Only the zero-point is shifted. The signal amplification remains untouched, as it shifts linear to the zero-point. In order to generate the 80 % signal, pin F and supply – must be connected.

Electrical wiring configuration **4-wire sensor**

connector type: **8P** (PC06A-12-8P)

0/4...20mA
0...10V

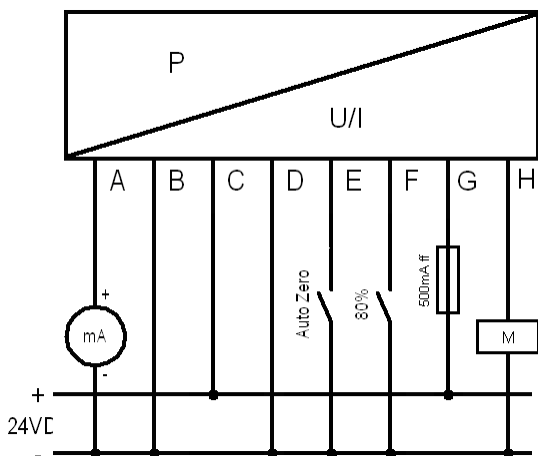
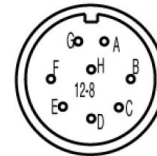

Pin	Function	Colour coding (Gneuss cable)
A	Signal +	Yellow
B	Signal -	White
C	Supply +	Brown
D	Supply -	Green
E	Auto Zero	Pink
F	80%	Grey
G	Switching output	Red
H	Switching output	Blue

In order for the Auto-Zero function to be activated, pin E and supply – have to be connected with each other. Only the zero-point is shifted. The signal amplification remains untouched, as it shifts linear to the zero-point. In order to generate the 80 % signal, pin F and supply – must be connected.

Electrical wiring configuration **3-wire sensor**

connector type: **8B** (Binder)M16

0/4...20mA
0...10V

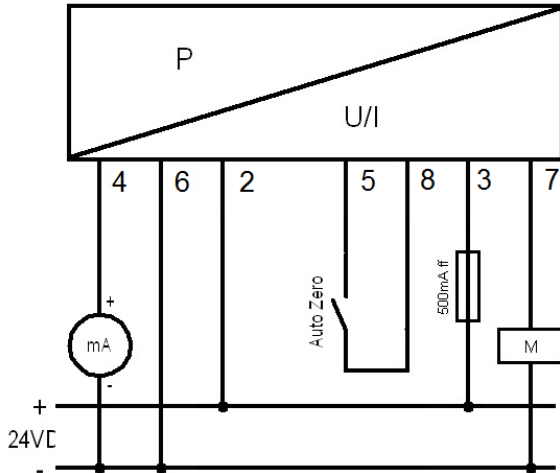
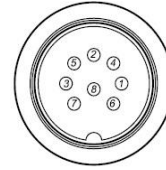

Pin	Function	Colour coding (Gneuss cable)
1	free	Green
2	Supply +	Brown
3	Switching output	Blue
4	Signal +	Yellow
5	Auto Zero +	Gray
6	Supply / Signal -	White
7	Switching output	Red
8	Auto Zero -	Pink

In order for the Auto-Zero function to be activated, pins 5 and 8 have to be connected with each other. Only the zero-point is shifted. The signal amplification remains untouched, as it shifts linear to the zero-point.

Electrical wiring configuration **3-wire sensor**

connector type: **8D** (PC06A-12-8P)

0/4...20mA
0...10V

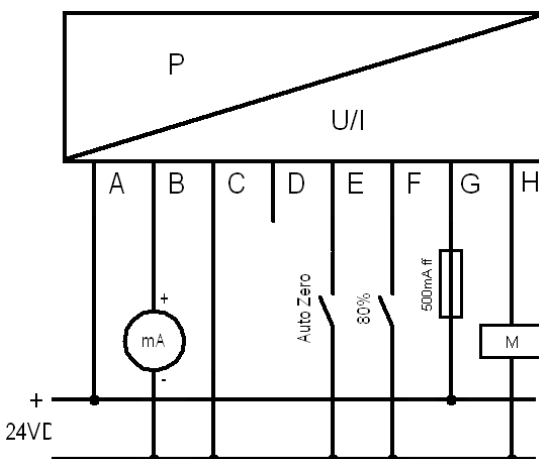
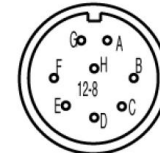

Pin	Function	Colour coding (Gneuss cable)
A	Supply +	Yellow
B	Signal +	White
C	Supply / Signal -	Brown
D	free	Green
E	Auto Zero	Pink
F	80%	Grey
G	Switching output	Red
H	Switching output	Blue

In order for the Auto-Zero function to be activated, pin E and supply – have to be connected with each other. Only the zero-point is shifted. The signal amplification remains untouched, as it shifts linear to the zero-point. In order to generate the 80 % signal, pin F and supply – must be connected.

Electrical wiring configuration **3-wire sensor**

connector type: **8H** (HARTING size 3A)

0/4...20mA
0...10V

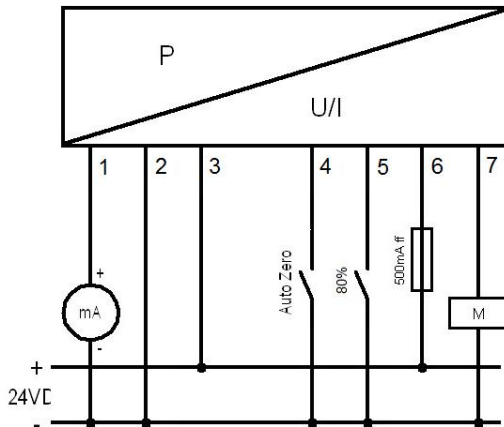
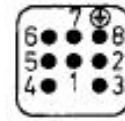

Pin	Function	Colour coding (Gneuss cable)
1	Signal +	Yellow
2	Supply / Signal -	White
3	Supply +	Brown
4	Auto Zero	Gray
5	80%	Pink
6	Switching output	Red
7	Switching output	Blue

In order for the Auto-Zero function to be activated, pin 4 and supply – have to be connected with each other. Only the zero-point is shifted. The signal amplification remains untouched, as it shifts linear to the zero-point. In order to generate the 80 % signal, pin 5 and supply – must be connected.

Electrical wiring configuration **3-wire sensor**

connector type: **7P** (62IN-5016-10-7P-4M)

0/4...20mA
0...10V

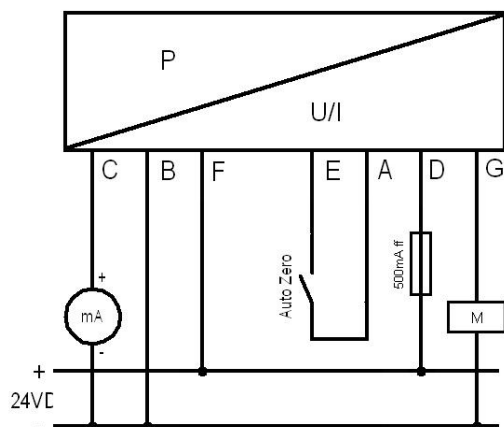
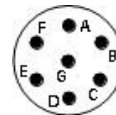

Pin	Function	Colour coding (Gneuss cable)
A	Auto Zero+	Pink
B	Supply / Signal -	White
C	Signal +	Yellow
D	Switching output	Red
E	Auto Zero -	Grey
F	Supply +	Brown
G	Switching output	Blue

In order for the Auto-Zero function to be activated, pins A and E have to be connected with each other. Only the zero-point is shifted. The signal amplification remains untouched, as it shifts linear to the zero-point.

Electrical wiring configuration **3-wire sensor**

connector type: **7S** (62IN-5016-10-7P-4M)

0/4...20mA
0...10V

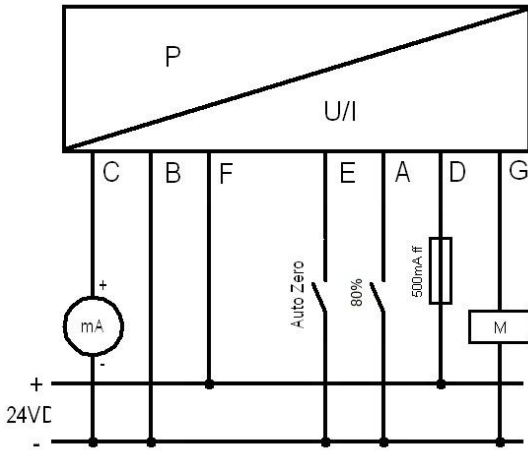
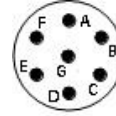

Pin	Function	Colour coding (Gneuss cable)
A	80%	Pink
B	Supply / Signal -	White
C	Signal +	Yellow
D	Switching output	Red
E	Auto Zero	Grey
F	Supply +	Brown
G	Switching output	Blue

In order for the Auto-Zero function to be activated, pin E and supply - have to be connected with each other. Only the zero-point is shifted. The signal amplification remains untouched, as it shifts linear to the zero-point. In order to generate the 80 % signal, pin A and supply - must be connected.

Electrical wiring configuration **3-wire sensor**

connector type: **6PA** (PT02A-10-6P)

0/4...20mA
0...10V

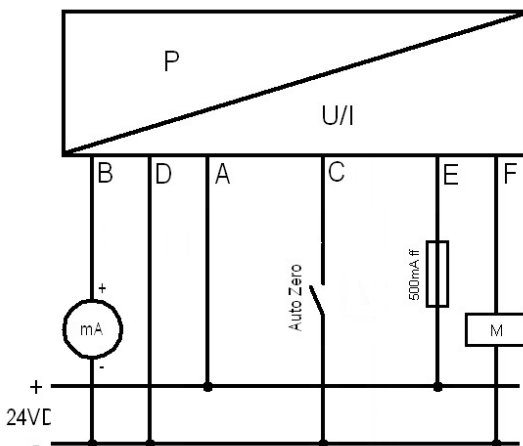
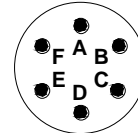

Pin	Function	Colour coding (Gneuss cable)
A	Supply +	Yellow
B	Signal +	White
C	Auto Zero	Brown
D	Supply/Signal/Auto Zero -	Green
E	Switching output	Pink
F	Switching output	Gray

In order for the Auto-Zero function to be activated, pin C and supply - have to be connected with each other. Only the zero-point is shifted. The signal amplification remains untouched, as it shifts linear to the zero-point.

Electrical wiring configuration **4-wire sensor**

connector type: **6PA** (PT02A-10-6P)

0...10V

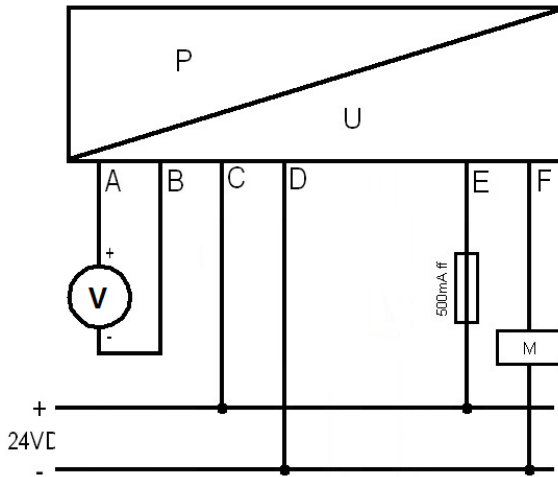
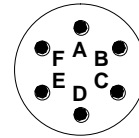

Pin	Function	Colour coding (Gneuss cable)
A	Signal +	Yellow
B	Signal -	White
C	Supply+	Brown
D	Supply -	Green
E	Switching output	Pink
F	Switching output	Gray

Pin B and D are conducted internally

The autozero function is activated via the optical button. Only the zero-point is shifted. The signal amplification remains untouched, as it shifts linear to the zero-point.

With regard to the combined pressure/temperature transducers (series DTA), furthermore, the respective temperature element has to be connected according to the connections indicated below.

Electrical wiring temperature element

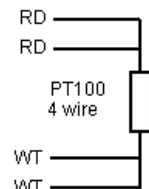
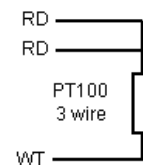
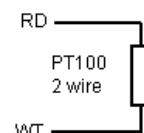
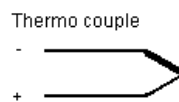
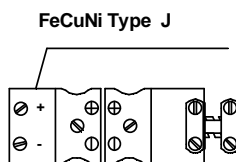

10. Technical Data:

Pressure range:	See order specification
Supply:	10...30 VDC
Output signal:	0...10 V; 0...20 mA; 4...20 mA (see order specification)
Calibration point:	80 % of measuring range
Accuracy:	$\leq \pm 0.50$ % FSO respectively $\leq \pm 0.25$ % FSO (see order specification)
Maximum overload:	150% of measuring range
Zero deviation with temperature variations at the membrane:	$\leq \pm 0.02$ bar from final value/°C
Zero deviation with temperature variations at the measuring head:	$\leq \pm 0.003$ % from final value/°C
Maximum temperature at the membrane:	300°C with NTX-filling (W) 400°C with Hg-filling (M) 500°C with NaK-filling (N)
Maximum temperature at the measuring head:	80 °C
Switching output:	Accuracy $\leq \pm 5$ % FSO Max. 48 V AC/DC Max. 500 mA Current limitation by means of semi-conductor fuses (fast acting) must be guaranteed on site.
EMC:	Electromagnetic disturbances and electromagnetic susceptibility according to EN 61326
Degree of protection:	IP 55

11. Dimensions

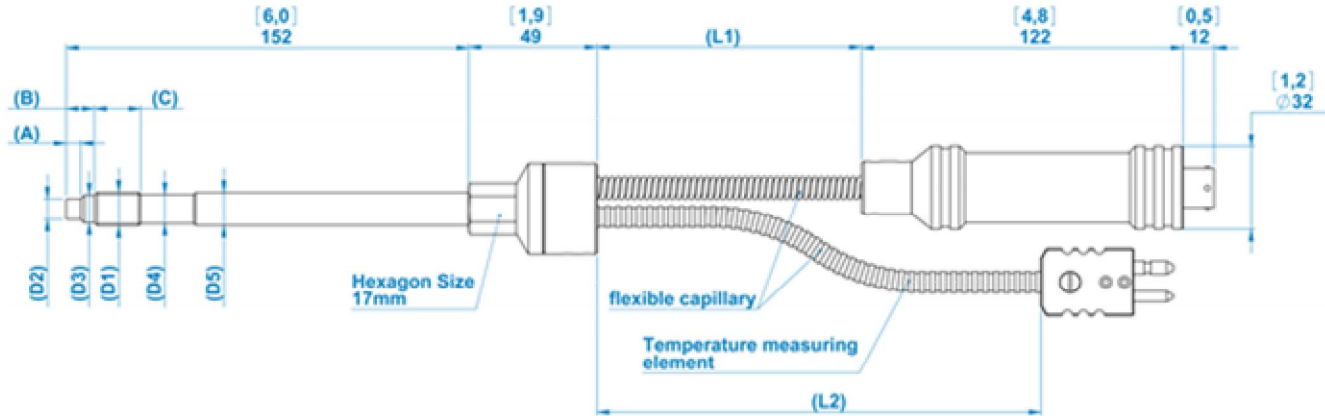

D1	D2	D3	D4	D5	A	B	C	SW
M18x1,5	10 ^{-0,05}	16 ^{-0,1}	16 ^{-0,5}	16	6 ^{-0,25}	14	20	17
1/2"20UNF 2A	7,8 ^{-0,5}	10,5 ^{-0,05}	10,5 ^{-0,5}	12,5	5,6 ^{-0,1}	10,8	17	17

For available versions see order specification.

Copyright

The copyright for this manual is the property of Gneuss Kunststofftechnik GmbH. This instruction manual is intended solely for the operating, monitoring, maintenance personnel and fitters. It includes recommendations and technical drawings, which may neither be copied completely nor in part, and which may not be duplicated or passed on to unauthorized third parties.

Gneuss Kunststofftechnik GmbH
Moenchhusen 42
32549 Bad Oeynhausen, Germany
Phone: +49 (0) 5731 5307-0
Fax: +49 (0) 5731 5307-77
Mail: gneuss@gneuss.com
www.gneuss.de