



# Operating Instructions

## DAIX Precision Pressure Transducer for the plastic industry



Zertifiziert nach  
ISO 9001

### Important advice:

-  Please read carefully through these operating instructions before mounting and commissioning the pressure transducer.
-  These operating instructions must be kept in an accessible place for further use.
-  The device must be installed, used and maintained only by personnel who are familiar with these operating instructions and the applicable regulations relating to safety at work and accident prevention.



# Measuring equipment for extruders

Precision Pressure Transducer DAIX

<b>1. General</b> .....	4
1.1 Information relating to proper use .....	4
1.2 Target group .....	4
1.4 Safety advice .....	4
1.5 Pack contents .....	5
<b>2. Product identification</b> .....	5
<b>3. Mounting</b> .....	5
3.1 General advice .....	5
3.2 Mounting steps .....	6
3.3 Electrical Installation .....	6
<b>4. Calibration</b> .....	7
4.1 Calibration of devices with 2-wire output signal .....	7
<b>5. Decommissioning</b> .....	8
<b>6. Maintenance</b> .....	8
<b>7. Recalibration</b> .....	8
<b>8. Repairs</b> .....	9
<b>9. Disposal</b> .....	9
<b>10. Guarantee conditions</b> .....	9

### 1. General

#### 1.1 Information relating to proper use

- The precision pressure transducers have been designed exclusively to register pressure of liquid, doughy or pasty compounds at high temperatures. These must be of a homogeneous nature. The point of use must be chosen such that a maximum differential pressure of 2% of the measurement range, based on the diaphragm area, is not exceeded. Any use going beyond the range of use described counts as improper.
- In the event of improper use, modification or damage to the device, no responsibility will be accepted and claims under the guarantee will be ruled out.

#### 1.2 Target group

These operating instructions are intended for specialist personnel.







#### 1.3 Symbols used

 : Warning

 : Advice

#### 1.4 Safety advice

In order to exclude risks to the user and his environment, the following advice should be noted:

-  The device must be installed, used and serviced only by personnel who are familiar with these operating instructions.
-  Applicable regulations relating to safety at work, accident prevention and country-specific installation standards must be complied with.
-  Should an intrinsically safe device be used in an Ex area, it is necessary to take note of the instructions „Installation of DAIX precision pressure transducers under environmental conditions subject to risk of explosion“, also supplied, in addition to these operating instructions. In this case, both sets of operating instructions apply only in combination.
-  The device must be operated only within specification (in this regard, refer to the technical data in the current data sheet.)
-  Always mount the device with neither pressure nor power applied.
-  Over the entire range of the heated precision pressure transducer, there is a risk of combustion. In the event of incorrect installation or removal while pressure is being applied, there is the risk of an escape of hot media under high pressure.

### 1.5 Pack contents

Ensure that all the parts listed are included in the scope of supply and have been supplied in accordance with your order.

- DAIX Precision pressure transducers
- these operating instructions
- in addition, for devices with ATEX Approval: Instructions "Installation of DAIX precision pressure transducers under environmental conditions subject to risk of explosion"

### **2. Product identification**

The name plate is used to identify the device. The most important information can be taken from this plate. The order code is used for the unambiguous identification of your product.

-  A name plate for devices with ATEX Approval will be found in the instructions "Installation of DAIX precision pressure transducers under environmental conditions subject to risk of explosion".

### **3. Mounting**

#### 3.1 General advice

- Handle this highly sensitive electronic measuring device carefully, both when packed and when unpacked.
- The device must not be thrown.
- Remove the packaging and, if fitted, the protective cap from the device only shortly before mounting it, in order to rule out damage to the diaphragm.
- Any protective cap supplied with the device must be kept.
- Following removal of the device, this protective cap must be fitted over the diaphragm again.
- Handle an unprotected diaphragm extremely carefully; this can easily be damaged.
- Do not apply any force to install the device.

### 3.2 Mounting steps

- Remove the device carefully from the packaging.
- When mounting the precision pressure transducer, care must be taken that the sensor hole corresponds to the dimensions listed below. The accuracy of fit can be checked by means of a test bolt.
- Before installation, the sensor thread should be provided with a heat-resistant grease.
- Should the machine part having the receiving hole still be at production temperature, a warming-up time for the sensor must be taken into account. Because of the thermal expansion, the sensor would settle.
- When screwing it in, care must be taken that the sensor is not misaligned or falls into the hole.
- Tightening torque for 1/2-20 UNF thread = max. 30 Nm  
Tightening torque for an M18x1.5 thread = max. 50 Nm

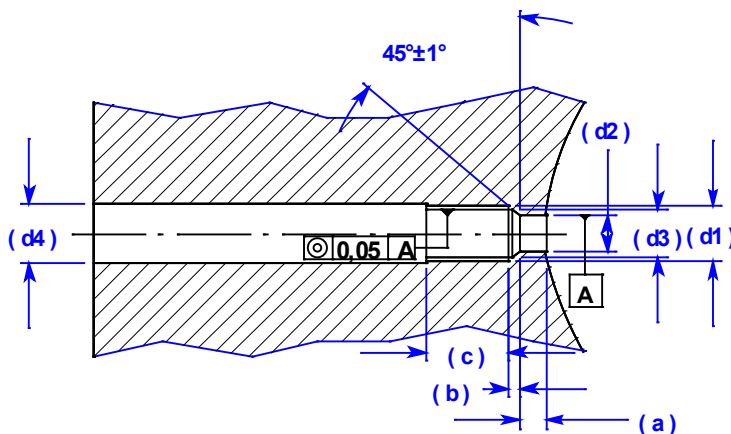

d1	M18x1.5	1/2''20UNF 2A
d2	Ø 10.1 <sup>+0.05</sup>	Ø 7.9 <sup>+0.05</sup>
d3	Ø 16.1 <sup>+0.1</sup>	Ø 10.7 <sup>+0.1</sup>
d4	Ø 20 <sup>+0.2</sup>	Ø 13 <sup>+0.2</sup>
a	6.1 <sup>-0.1</sup>	5.7 <sup>-0.1</sup>
b	4 <sup>-0.2</sup>	3.2 <sup>-0.2</sup>
c	25	19

### 3.3 Electrical Installation

Connect the device electrically in accordance with the information on the name plate, the following table and the connection diagram. Our precision pressure transducers are fitted with high-quality, rugged plug connections. The soldering of the connecting lead should be carried out very carefully, since otherwise signal transmission errors can occur. We recommend the use of our tailor-made connecting leads, which can be obtained from stock.

#### Connecting pin assignment table

Design	Pin A	Pin B	Pin C	Pin D	Pin E	Pin F
2-wire current signal 4 ... 20 mA, Ex-proof	Signal +	Signal -	Auto Zero +	Auto Zero -	Calibration +	Calibration -
Color-code cable connection	YELLOW	WHITE	BROWN	GREEN	PINK	GRAY

### Connection circuit diagrams:

 In the case of an Ex design, the connection circuit diagram must be taken from the instructions "Installation of DAIX precision pressure transducers under environmental conditions subject to risk of explosion". The operating voltage must be max. 30 V<sub>DC</sub> and must be taken only from an intrinsically safe source.

 For the electrical connection, a screened and twisted multi-way cable should preferably be used.

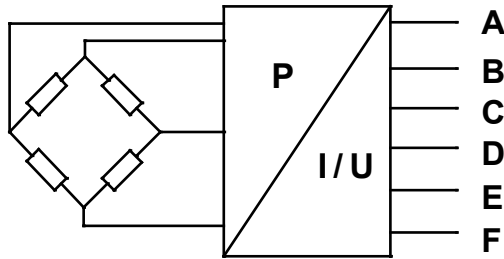

## 4. Calibration

Before it is put into service, the sensor must be calibrated to the appropriate evaluation system. The calibration procedure must be carried out with the plant heated up but unpressurized. The procedure is described below.

### 4.1 Calibration of devices with 2-wire output signal

Precision pressure transducers with a 2-wire output signal are equipped with an integrated measurement amplifier which, depending on the design, provides a standard signal corresponding to the pressure range.

#### Auto Zero:

Following mounting, electrical installation and adequate heating of the precision pressure transducer, zero-point adaptation must be carried out. This can be done by means of the Auto Zero function. The function is triggered by connecting the Auto Zero pins (cf. connecting pin assignment table). The output signal is automatically set to the starting value of the output signal range as a result (to 4 mA in the case of a 4 ... 20 mA output). Possible offset shifts are compensated for as a result.

### 80% Calibration:

Scaling of the measuring range can be carried out with the 80% calibration. Depending on the design, the function is triggered by connecting the calibration pins (cf. connecting pin assignment table).

Output signal range	Output signal at 80% calibration
4 ... 20 mA	16.8 mA

Example: For 80% calibration in the case of a 2-wire 4 ... 20 mA current signal, Ex-proof, the contacts E and F on the connector must be connected. The device then provides an output signal which corresponds to 80 per cent of the measuring range. After the adjustments have been carried out, the connection made between the pins must be removed again and the precision pressure transducer can be put into service.

## 5. Decommissioning





The precision pressure transducer must be removed in the heated state (melting point of the plastic). During sensor removal, care must be taken that the diaphragm is not knocked.

## 6. Maintenance

This device is maintenance-free. If necessary, the device can be cleaned with non-aggressive cleaning solutions.

In order that cleaning of the diaphragm, the sealing surface and the thread can be carried out, the sensor in this region must be at the temperature of the melting point of the plastic. The diaphragm and the sealing surface can be cleaned with a soft cloth. The thread can be cleaned carefully with a small brass brush. (In the process, do not touch the diaphragm in any case!).

-  Never use sharp objects or compressed air to clean the diaphragm.
-  If the diaphragm has come into contact with pollutants, this must be taken into account during the cleaning and the appropriate protective measures taken.
-  Inappropriate cleaning can lead to irreparable damage to the diaphragm.

## 7. Recalibration

During the lifetime of the device, it is possible for the offset to shift. This can lead to a signal value being output which deviates from the set measuring range starting value. It is likewise possible for the full-scale value to shift. This would lead to a signal value being output which deviates from the set measuring range end value.

Should one of these two phenomena occur after long use, recalibration is recommended, in order to be able to ensure high accuracy.

For the purpose of recalibration, the Auto Zero und 80% Calibration functions are available (these will be found under 4. Calibration).



## 8. Repairs

In the event of malfunctions which cannot be rectified, your device should be sent back to us for repair. The device should be cleaned first and packed safely against breakage. A Return Note with a detailed description of the fault should accompany the defective device. If your device has come into contact with pollutants, a Decontamination Declaration will also be needed. Appropriate templates will be found on our home page at [www.gneuss.com](http://www.gneuss.com). If you send in your device without a Decontamination Declaration and doubts relating to the medium used arise in our Service Department, the repair will be started only after an appropriate declaration has been submitted.



**If the device has come into contact with pollutants, appropriate precautionary measures must be taken during cleaning.**

Our Service address:

Gneuß GmbH, MT-Service, Mönichhusen 42, D - 32549 Bad Oeynhausen

## 9. Disposal

The device must be disposed of in accordance with European Directives 2002/96/EC and 2003/108/EC (Waste Electrical and Electronic Devices). Waste devices must not get into domestic waste!



**If the device has come into contact with pollutants, this must be taken into special account in the event of disposal!**

## 10. Guarantee conditions

The guarantee conditions are subject to the statutory guarantee period of 24 months, applicable from the date of delivery. In the event of improper use, modification or damage to the device, we will rule out any claims under the guarantee. Damaged diaphragms will not be recognized as a guarantee case. Likewise there is no claim under the guarantee if the deficiency has arisen as a result of normal wear and tear.





# Measuring equipment for extruders

Precision Pressure Transducer DAIX

The contents of these operating instructions were up-to-date at the time of printing. They were drawn up to the best of our knowledge and belief. Despite this, it is possible that errors have crept in. Unfortunately, we cannot accept responsibility for erroneous statements and their consequences.

– The right is reserved to make technical changes –

**Gneuss Kunststofftechnik GmbH**  
**Moenichhusen 42**  
**32549 Bad Oeynhausen, Germany**  
**Phone: +49 (0) 5731 5307-0**  
**Fax: +49 (0) 5731 5307-77**  
**Mail: [gneuss@gneuss.com](mailto:gneuss@gneuss.com)**  
**[www.gneuss.de](http://www.gneuss.de)**

|