

LEHNER **LIFTTECHNIK**

Installation Manual

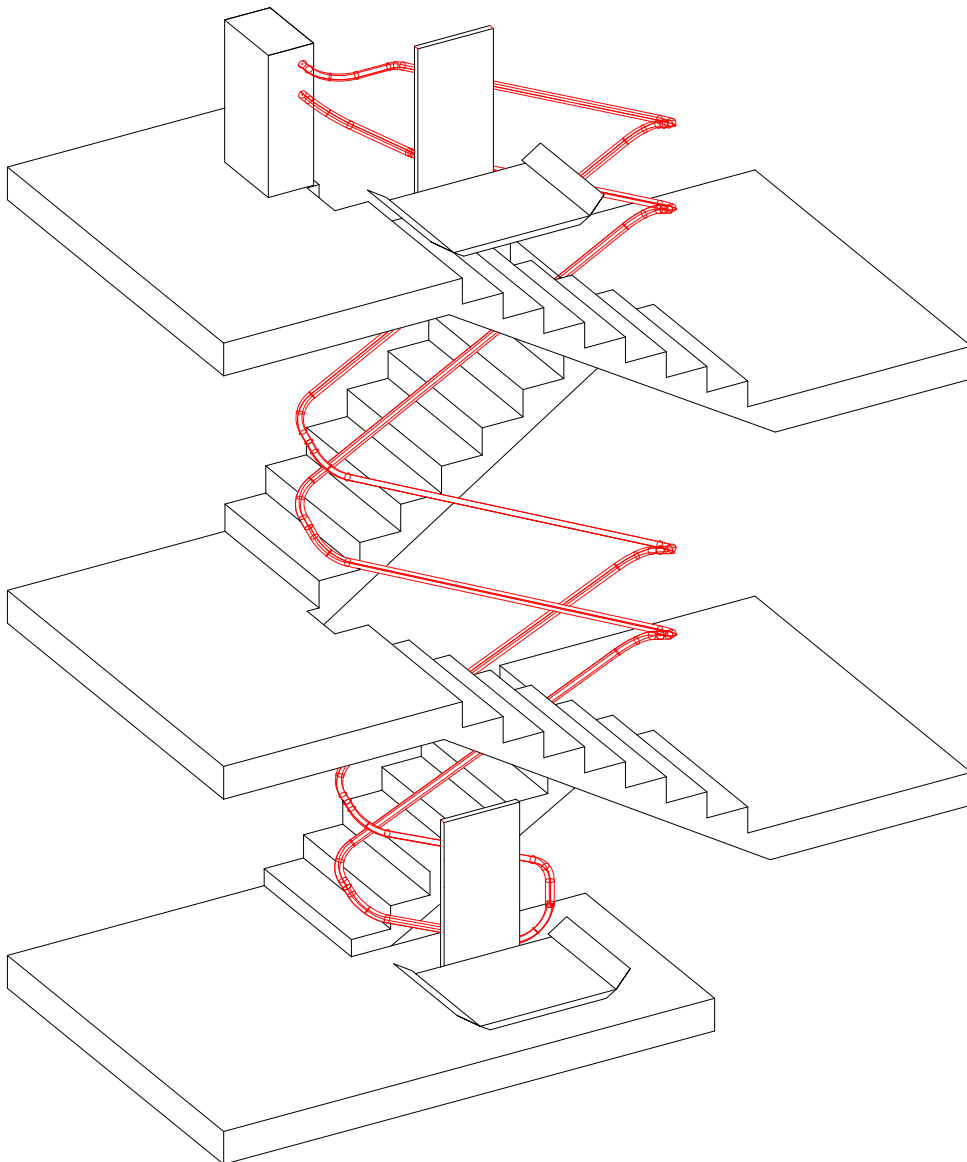

≡ Ω MEGA - F ≡
stairlift
CE

CONTENTS

OBSERVE THE FOLLOWING POINTS BEFORE INSTALLATION!	3
STEP 1. – INSTALLATION OF THE GUIDE RAILS	4
STEP 2. INSTALLATION OF THE DRIVE BOX	6
STEP 3. INSTALLATION OF THE TENSION AND SUPPORT ROPE SYSTEM	6
Installing the tension rope	8
Installing the support rope	11
STEP 4. INSTALLATION OF THE PLATFORM ONTO THE RAIL/ROPE SYSTEM	15
STEP 5. TIGHTENING AND CONNECTION THE ROPES	16
STEP 6: ELECTRICAL CONNECTIONS	16
STEP 7. MOUNTING THE MECHANICAL STOP STATION ASSEMBLY	18
STEP 8: ADJUSTMENT OF THE LOADING RAMPS	20
STEP 9: PROGRAMMING THE UNIT	21
Programming the drive speeds - Teach-in mode	27
ERROR LIST AND EXPLANATION	30
POSSIBLE ERRORS AND STATUS EXPLANATION OF THE PLATFORM	32
FINAL CHECKS	34
EMERGENCY OPERATION	35
EXPLANATION OF THE ELECTRICAL CONCEPT	36
DRIVE UNIT	37
Drive unit control board	37
Buttons and Jumpers	40

Main contactor control board (MCCB)	41
PLATFORM CONTROL.....	41
Platform control board overview	42
CONFIGURATION OF THE REMOTE RADIO CONTROLS	46
ADJUSTMENTS ON THE PLATFORM MECHANICS	47
Overview of the platform mechanics	47
Adjustment of the platform inclination.....	48
Dismantle the platform floor	49

Observe the following points before installation!

Installation teams must have a general knowledge in

- basic mechanical engineering and providing adequate fixation of the rails and pillars
- reading and understanding circuit diagrams and wiring schematics.

In order to save time and energy, it is wise to be properly prepared before installing the OMEGA-platform lift. The following points will assist in completing the installation efficiently and on schedule:

- Have a **complete electrical and mechanical tool kit on hand.**
- Check beforehand what fixing materials (screws, anchor bolts, adhesives) are required for the proper fixing of the rails to the wall or the pillars to the floor. These materials are not included in the delivery! The installation company is responsible for the fixing of the rail to the wall or the pillars to the floor/steps!
- Have the correct on-site power supply set up using the correct fuses. The power supply has to be connected to the motor box at the upper end of the rail.
- **Assemble a team of 2 technicians to mount the plant.**
- **Check the packages for shipping damage** and missing parts before bringing the lift to the site.
- Open the installation package (which is in the box of the OMEGA lift). Review the enclosed Installation notes, if supplied. In some cases, additional components must be brought to the site.
- Refer to the tube layout drawing and familiarise yourself with the tube configuration.

The following tools will be required to finish the installation successfully:

- A complete toolset for mechanical and electrical works
- Voltmeter
- Drilling machines
- Drills, thread cutter
- Fixing material
- Water level with angle indication



Step 1. – Installation of the guide rails

- The rail can either be fixed directly to the wall or to free standing pillars that are fixed either to the steps, the side of the staircase or the ground floor. Generally the following important measures are given to start the installation at the lower landing:

W – **perpendicular distance** step nose to underside of lower rail
X – floor to **lower end of rail connection bracket** (of center of rail)
Y – first step to **side of rail connection bracket**
Z – floor to **underside** of lower rail

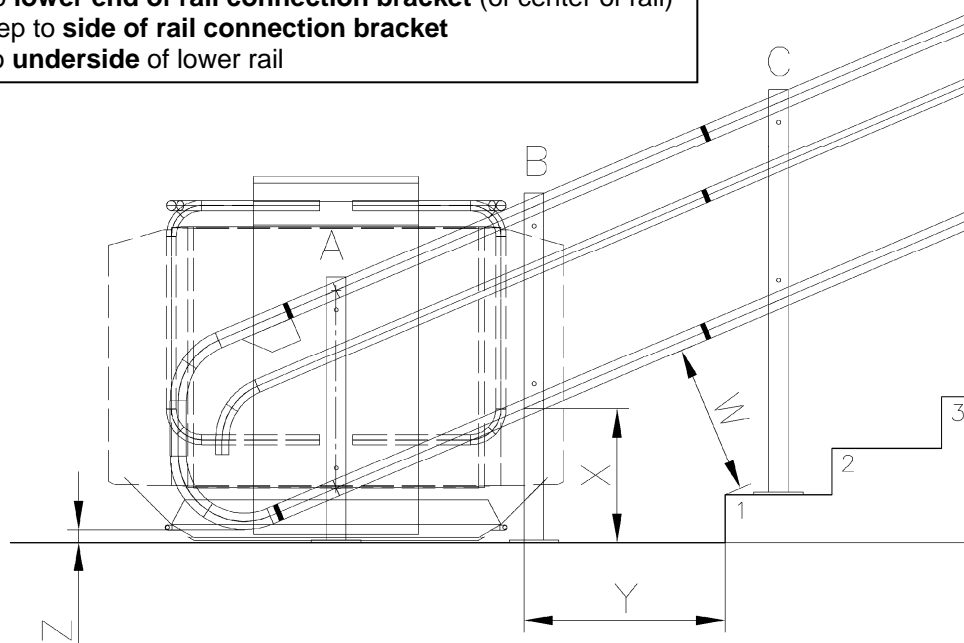

- In case of support pillars, these have the serial letters indicated in the drawing that are also stamped on the pillar base plate in order to identify the correct pillar. To facilitate fixing of pillars it helps to provisionally fix the pillars with rope clamps.



- Drill the mounting holes, starting at the bottom with Pillar A and working up the system. In concrete, use a 10 mm diameter masonry bit. Otherwise use a dowel and drill a 12 mm hole!. When mounting in wood, use a standard 6 mm wood drill. Pass the lag bolt (screw materials like lag bolts, nuts, washers, etc., are not included in *Lehner-Lifttechnik* delivery-specification) through a washer, and screw it into the end of a plug anchor. The anchor can then be tapped into position using a small hammer. Avoid spilling dust into the hole.
- Check each connection for damage and lightly grease both ends before joining the tube sections. Fasten the connection with the splice bolts and nuts provided.
- Check the clearance dimensions. Ensure that the actual measurements correspond with the clearance dimensions on the layout drawing.
- **Remember:** Vertical clearances are measured from the centreline of the tube (this is also the lower point of the bracket on the railway) to the stair nose or to the floor.
- With the tubes in position, check all splice connections for alignment. Note that the proper fit of the splices is critical to ensure smooth lift operation. When fixing the lift in place, smooth out any misalignment using shims behind the mounting struts.
- On longer lifts some discrepancies may occur. Try to average them out while making a final check for landing clearances, splice alignment and fit.
- With the system in place, check that all struts and support pillars are plumb. Use a water level for this work!
- Clean any debris from the inside of the tubes.



Step 2. Installation of the drive box

When the tube system is anchored in place you can mount the drive box on the upper rail end. Dismantle the cover as shown on the pictures below.

It is important to add washer and spring washer to the fixing screws, otherwise the screws will hit the drive gear tooth wheel in the back of the drive unit.

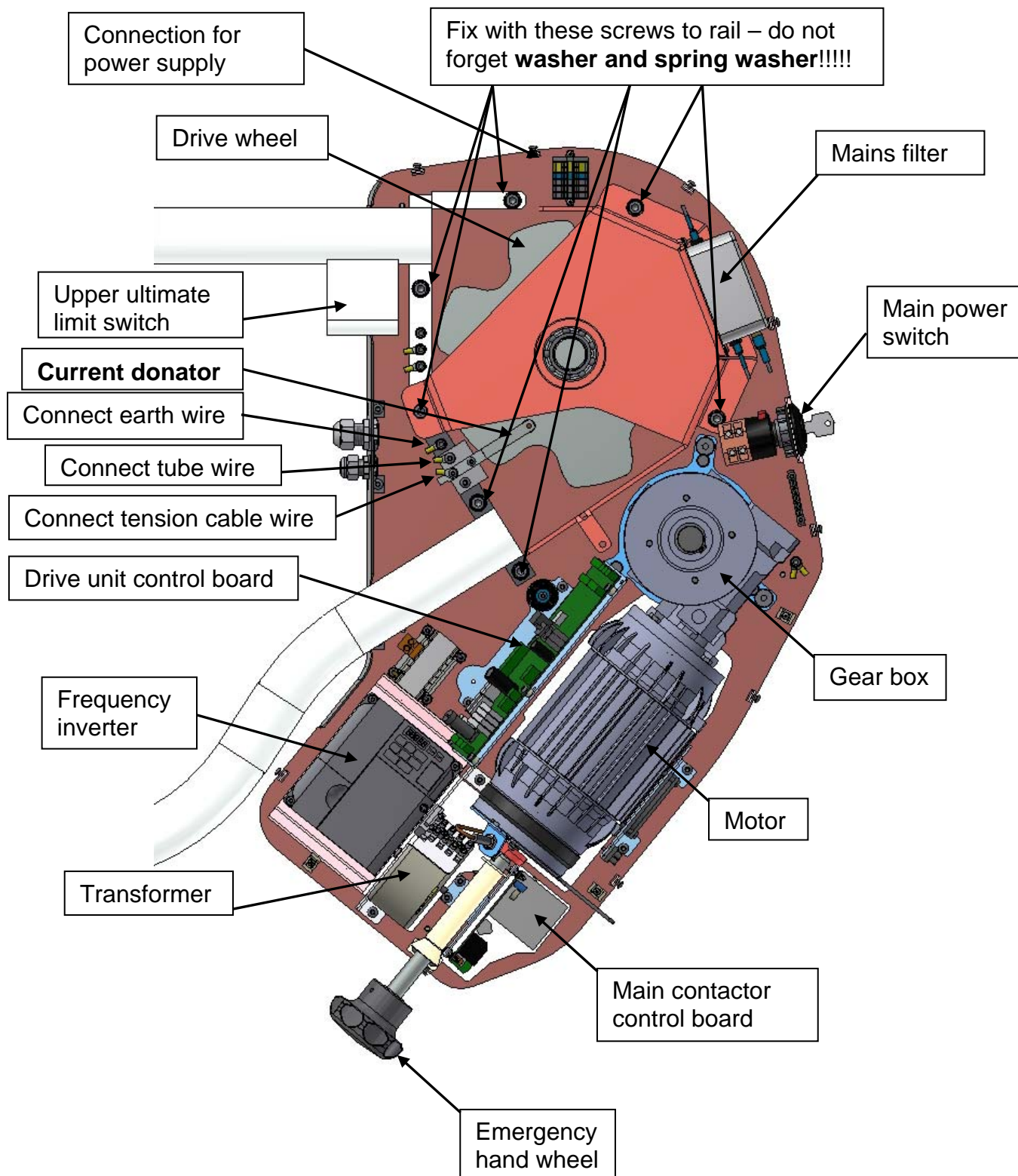

Step 3. Installation of the tension and support rope system

- Dismantle the mains filter from the drive wheel cover and also the complete drive wheel cover from the drive wheel



- Remove the over speed governor tube section at the bottom of the system and put the complete rope on the bottom close to the upper motor and make sure it does not get dirty.

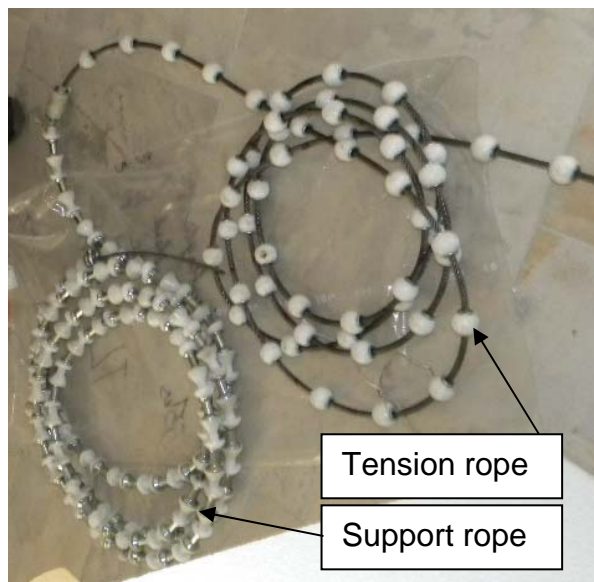

Installing the tension rope

- Start feeding the tension rope into the upper tube of the guide rail. Put as much tension rope in the tube until the cable sticks out around 500mm on the lower rail end of the upper tube.
- Then put the fixing bracket for the tension rope on the end of the tensions rope. See the following page for detailed description.



- Put the tension rope support connection onto the end of the tension rope.

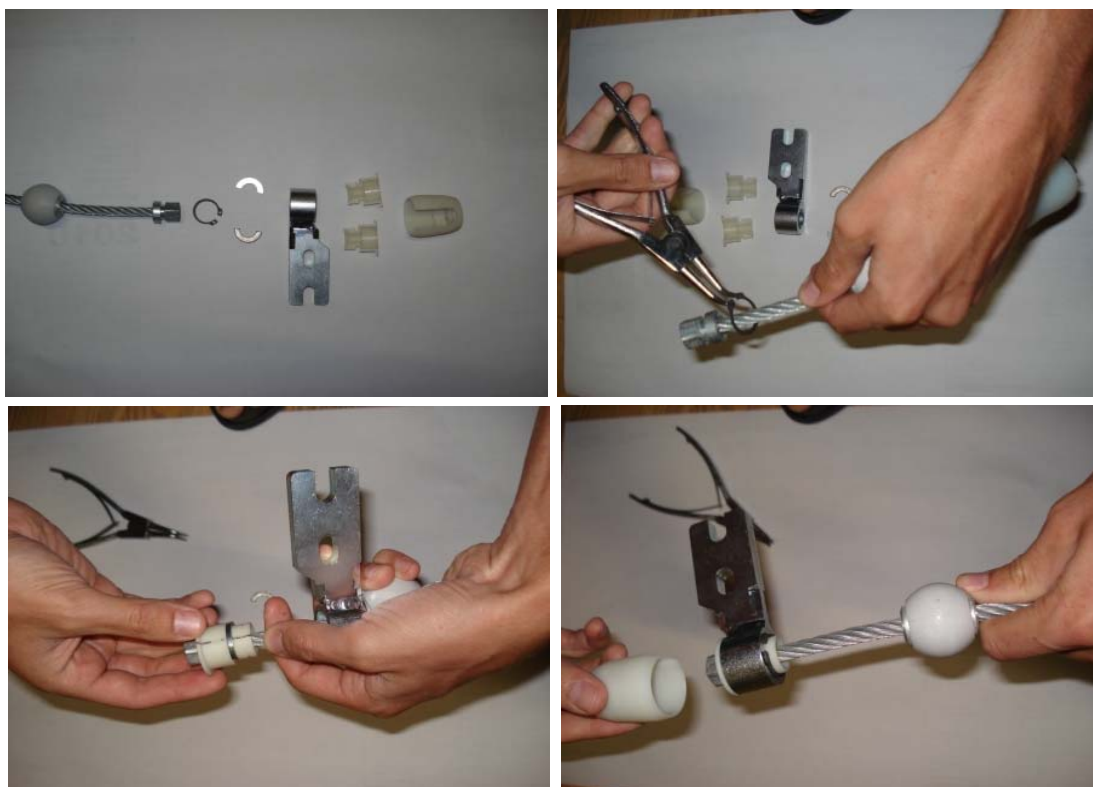

- Pull back the tension rope inside the upper tube so that it stops where you want to put the platform onto the rail. The fixing bracket must be a minimum of 810mm above ground floor level.

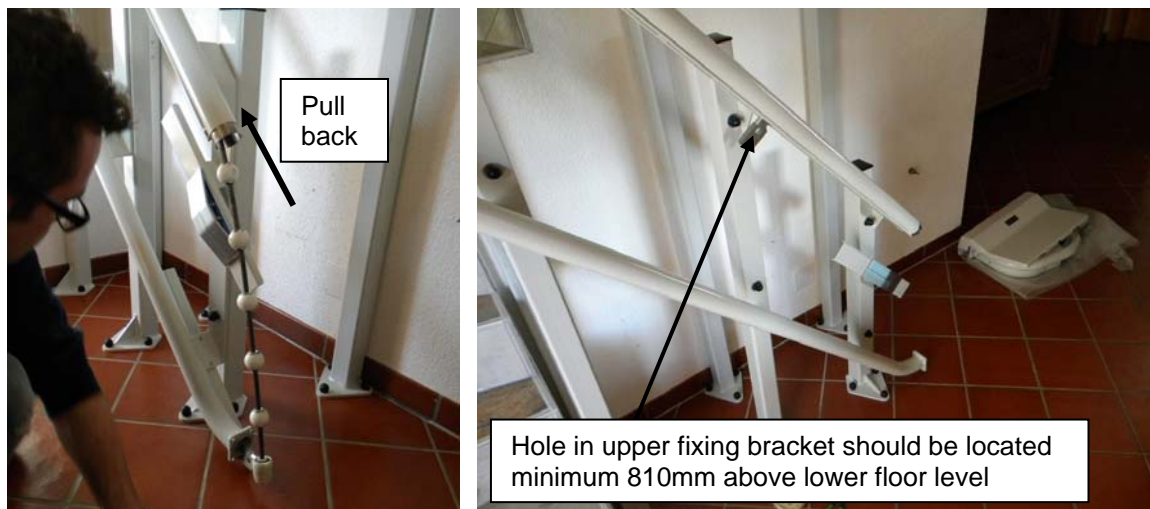

- Add the current collector into the upper tube next to the fixing bracket. Make sure the spring between the current collector and the upper fixing bracket is securely attached to the current collector. This spring is responsible to make the electrical contact between the tension cable and the platform control board.

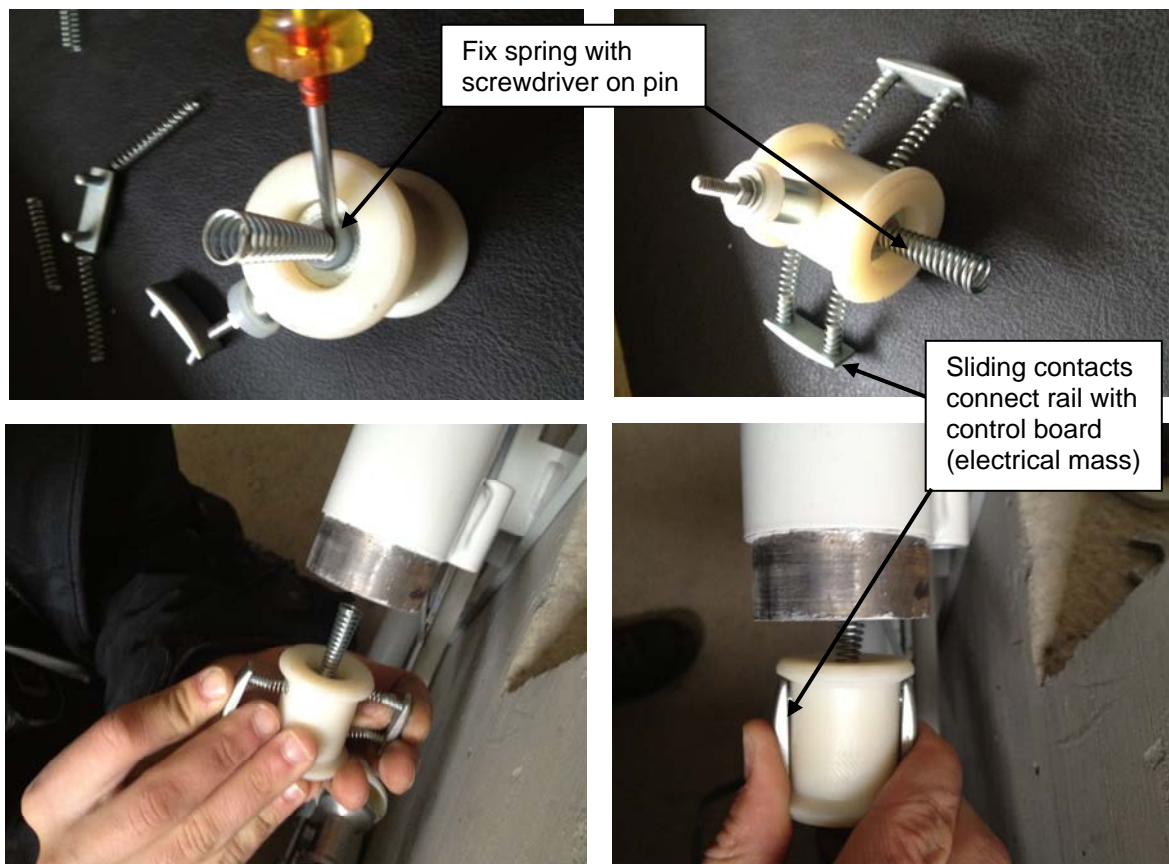

- Please note that there is only 1 spring installed between the tension rope and the current collector! There is not spring between the collector and the support rope!!!

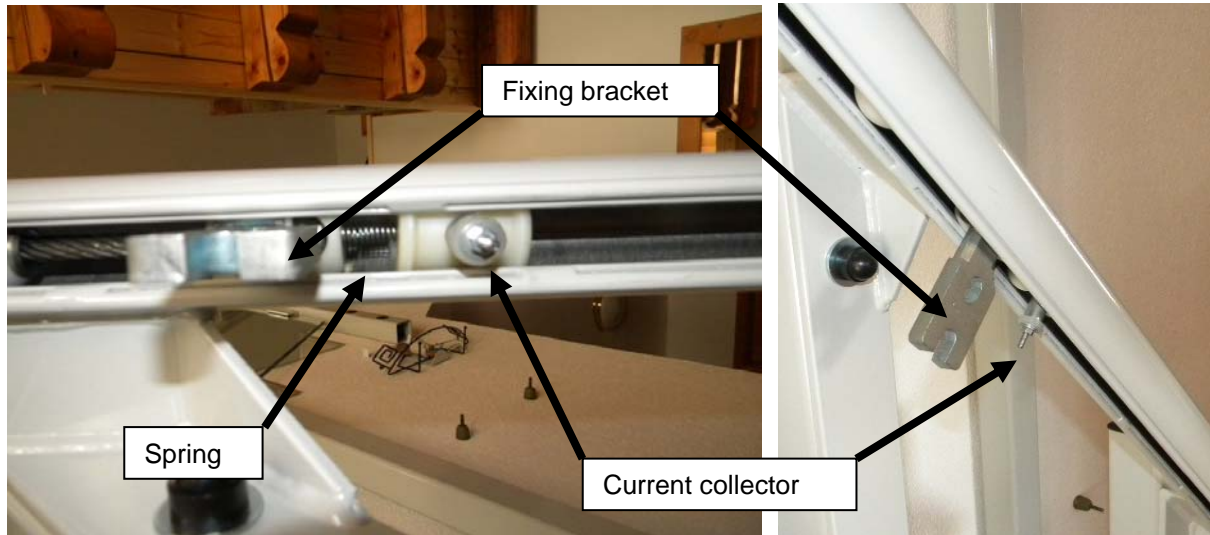

Installing the support rope

- Feed the support rope into the lower tube and make sure the tension rope engages well into the motor drive wheel. Make sure you put some cover on the lower floor so the support rope does not get dirty when it gets out on the lower tube end.

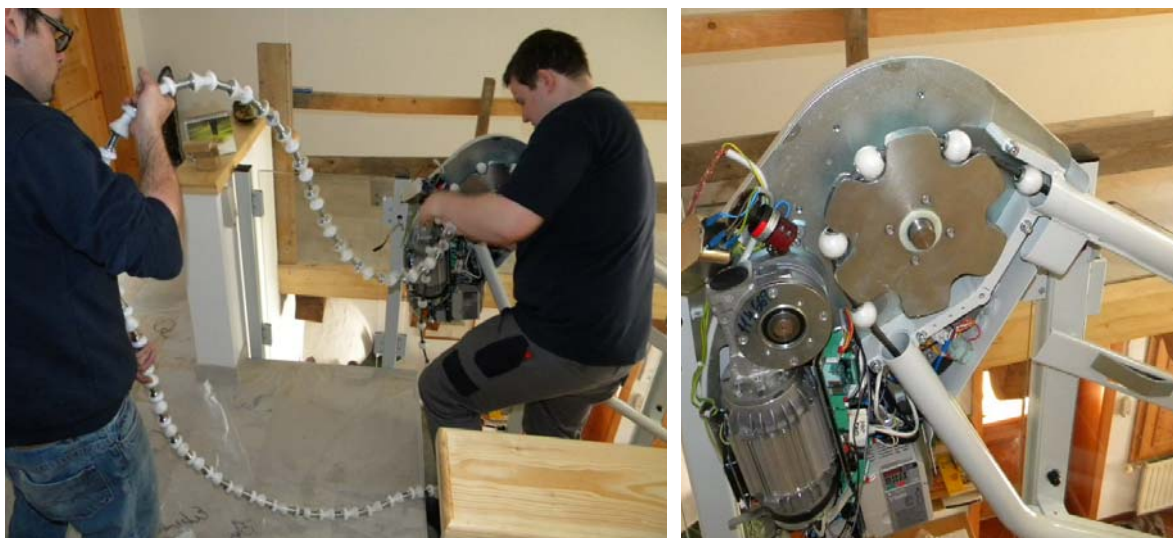

- Enter the lower rope into the over speed governor tube section. It might be necessary to release the tension spring in order to facilitate entry of the rope into the safety gear tube section. This spring later should be set to the same tension again after the rope is installed!

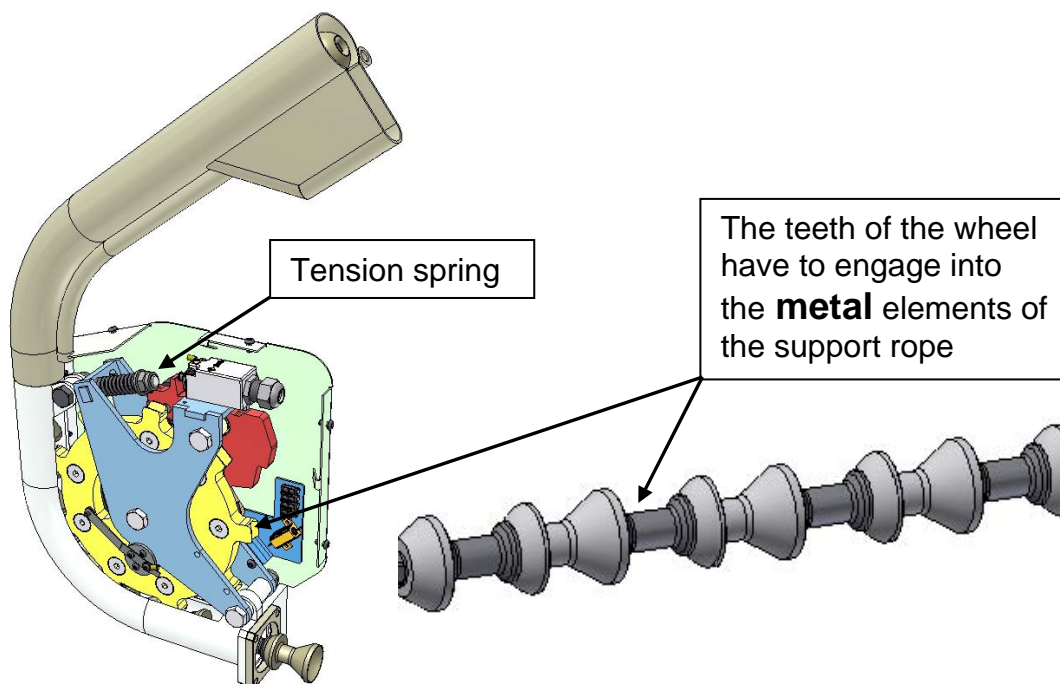

- Loosen this spring – move the safety nut to the end of the screw. After tensioning the cable put the safety nut back into its original position.

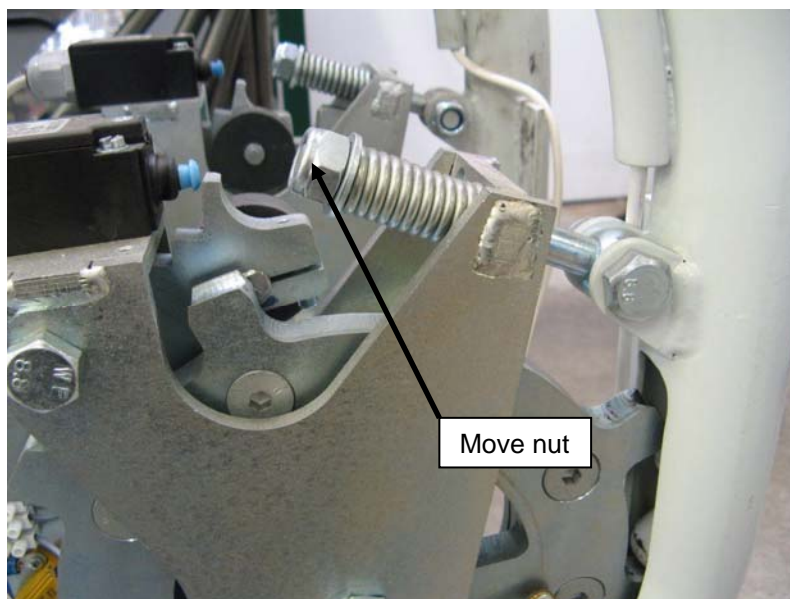

- Now you need to define the right length of the support rope. Approach the over speed governor tube to the lower rail end to measure necessary support rope element length. Check how many support elements of the tension rope have to be removed so that there is still enough space for the fixing bracket of the support rope.

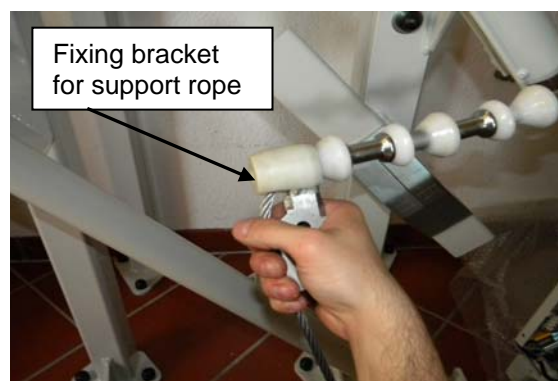
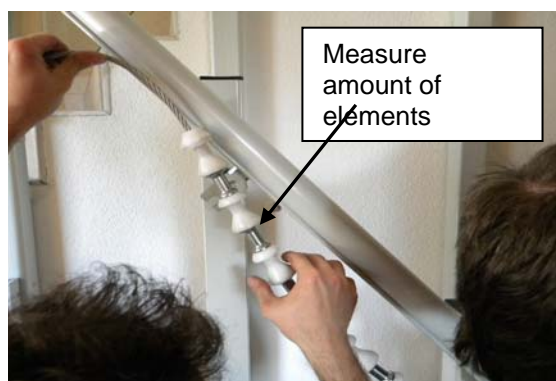
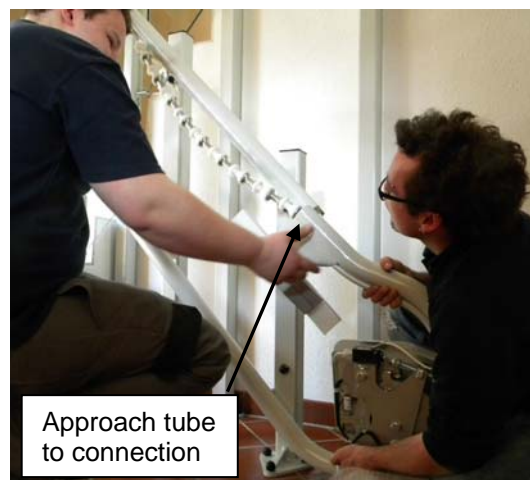

- It is important that there are not too many support elements on the support rope as then it is not possible to tension the cable. A gap between the last support element and the fixing bracket of the support rope is ideal. This gap depends on the length of the rail and number of curves and is later reduced when the rope is tensioned! Below a table that shows approximate gap length based on rail length.

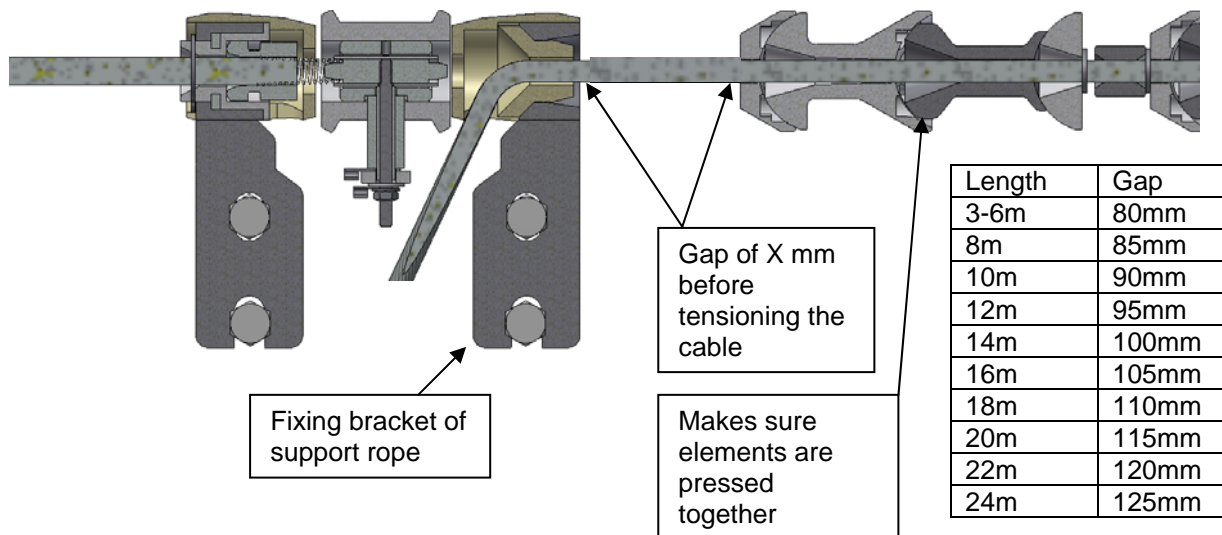

- Below it can be seen how the rope system should look before putting the platform onto the rail.



- Add the drive wheel cover and the mains filter again onto the drive wheel. This cover must be fixed before the rope is tensioned!



Detailed diagram of the rope fixing assembly to the platform sidewall

Please note that there is only 1 spring installed between the tension rope and the current collector! There is not spring between the collector and the support rope!!!

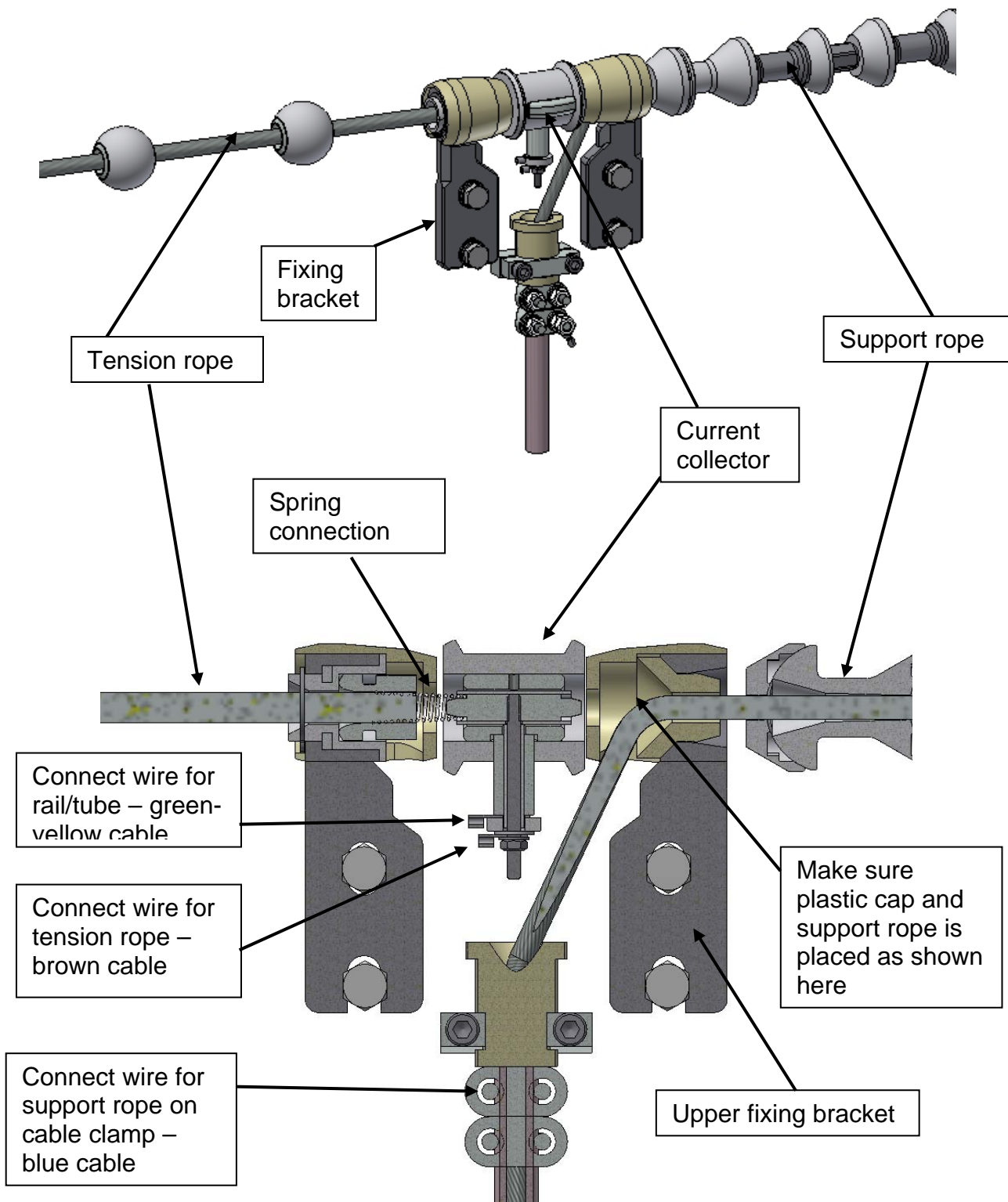

Step 4. Installation of the platform onto the rail/rope system

When the rope system is securely in place, begin mounting the carriage. Complete the following steps:

- Bring the carriage to the bottom of the tube system and unwrap it.
- Remove the conical rollers from the lower carriage.
- Carefully lift the carriage into position, guiding the upper carriage rollers onto the upper tube. Ensure that the rope fixing brackets fit between the bosses of the upper carriage. Be careful not to scratch the paint on the tubes.

Note: The carriage weighs about 90 kg, so two people should install it to ensure safety and avoid damage.

- Tighten the screws that fix the carriage to the fixing brackets of the tension and support rope.
- Install the conical rollers again on the lower carriage.

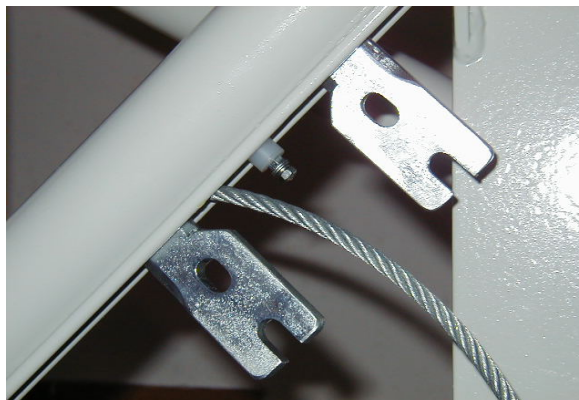

Step 5. Tightening and connection the ropes

Note: Make sure you reinstalled the cover of the drive box before tightening the rope!

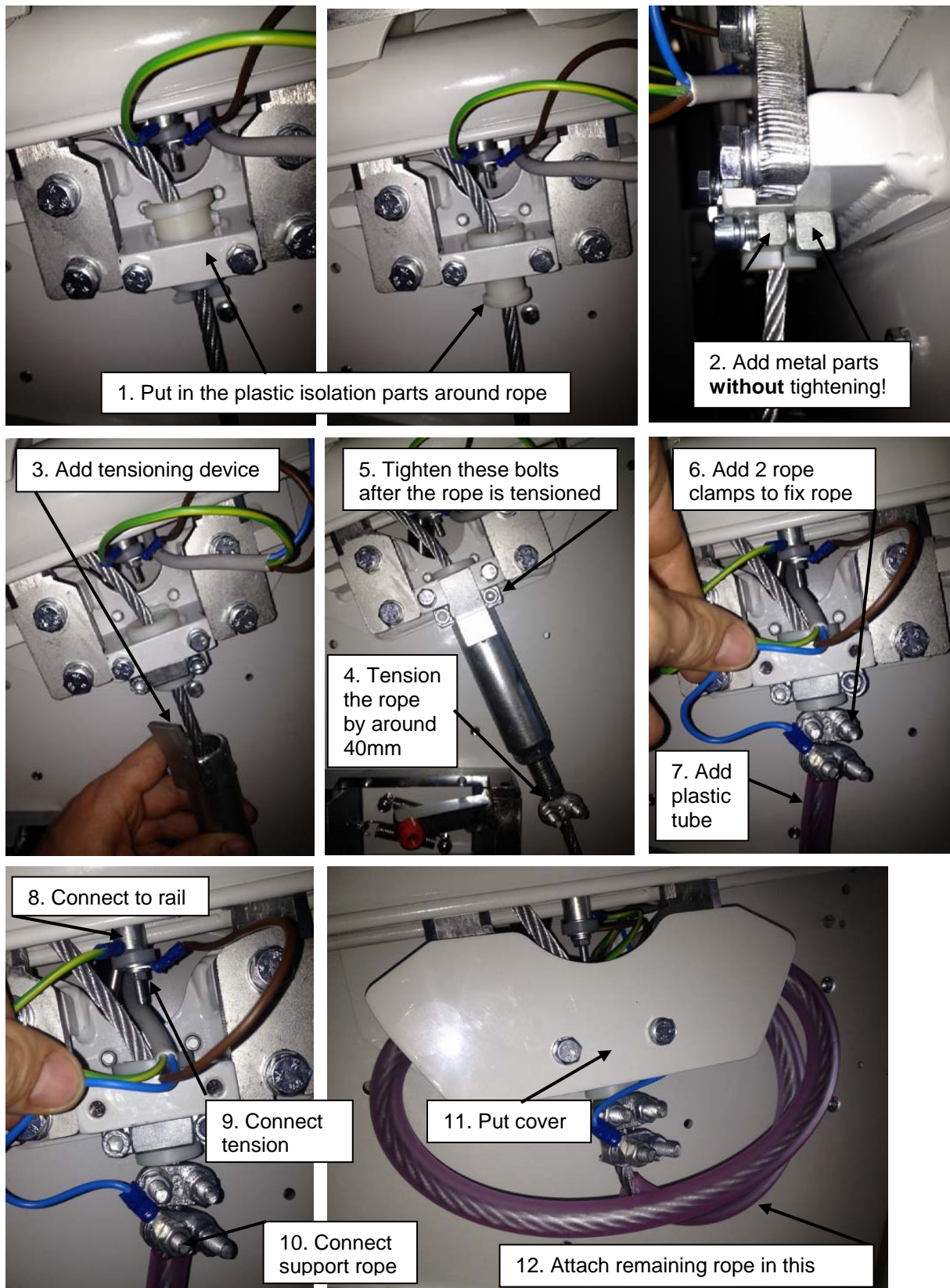

Step 6: Electrical connections

- Connection the tension rope and the rail from the current collector, and the support rope to the platform control board as described on the previous page.
- Connect the tension rope wire from the drive unit control board to the current donator on the drive wheel and also connect the earth and the tube wire to the rail next to the current donator.

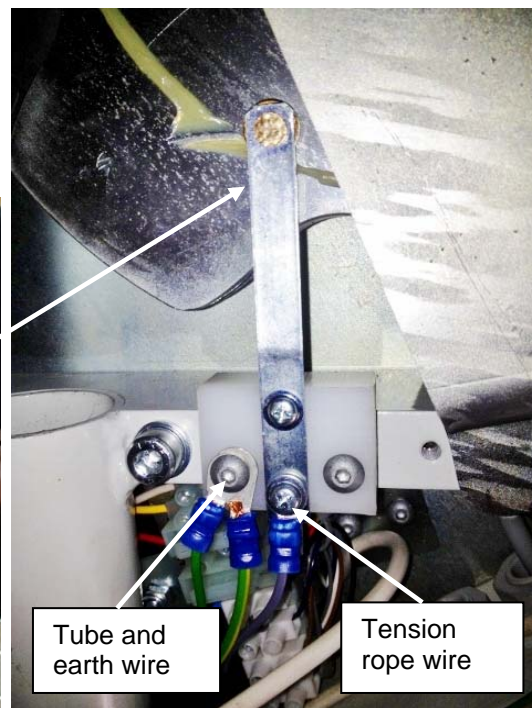
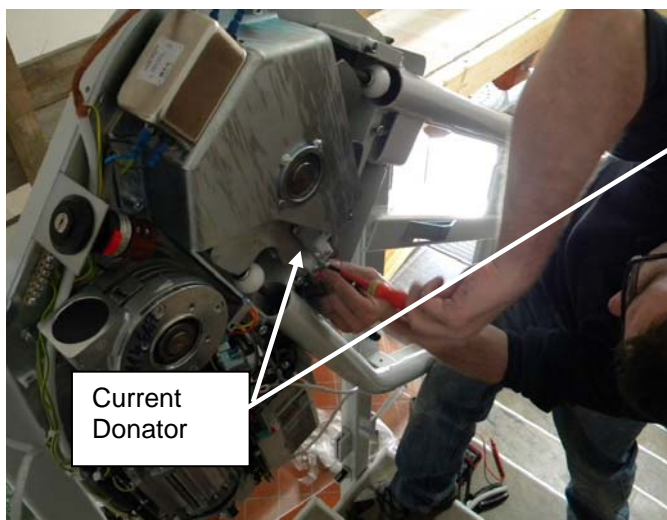

- Connect the upper ultimate limit switch to the drive unit control board – connector name “NESO”.
- Connect the on-site main power supply to the main power switch on the drive unit.

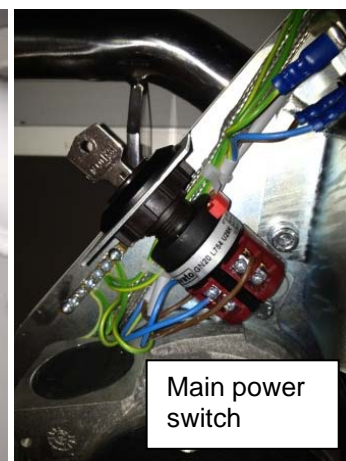

Step 7. Mounting the mechanical stop station assembly

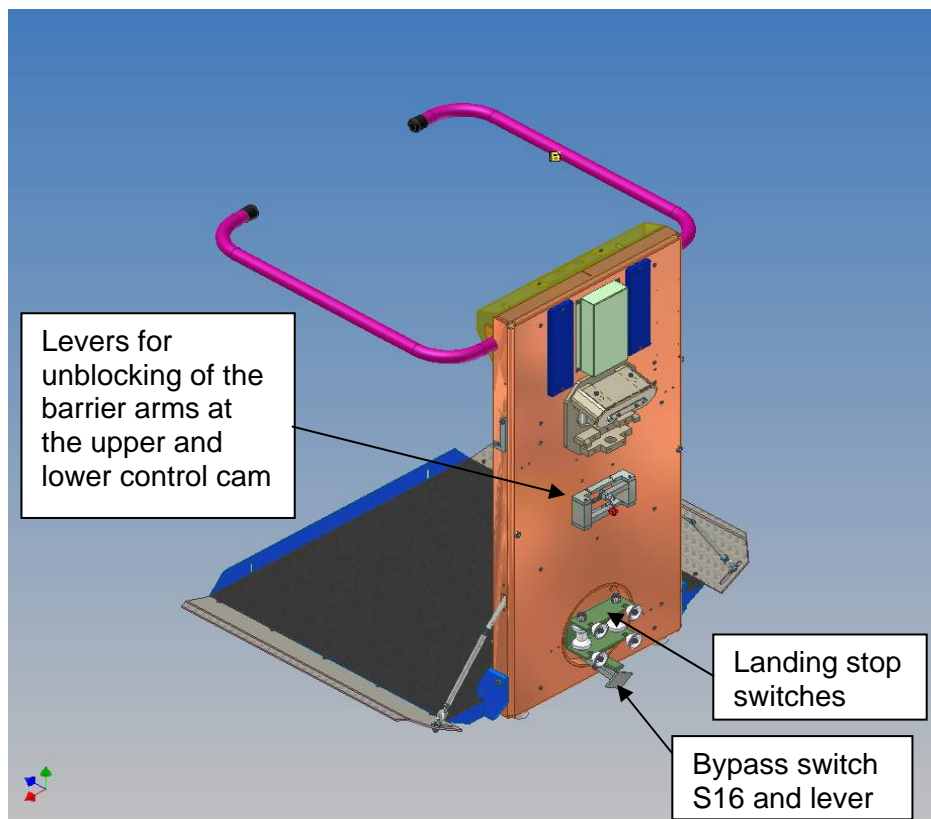

- Adjust the position of the control cam in reference to the limit switch device on the rail. The bypass switch has to be activated **before** the levers for unblocking of the barrier arms touch the control cams on the rail.

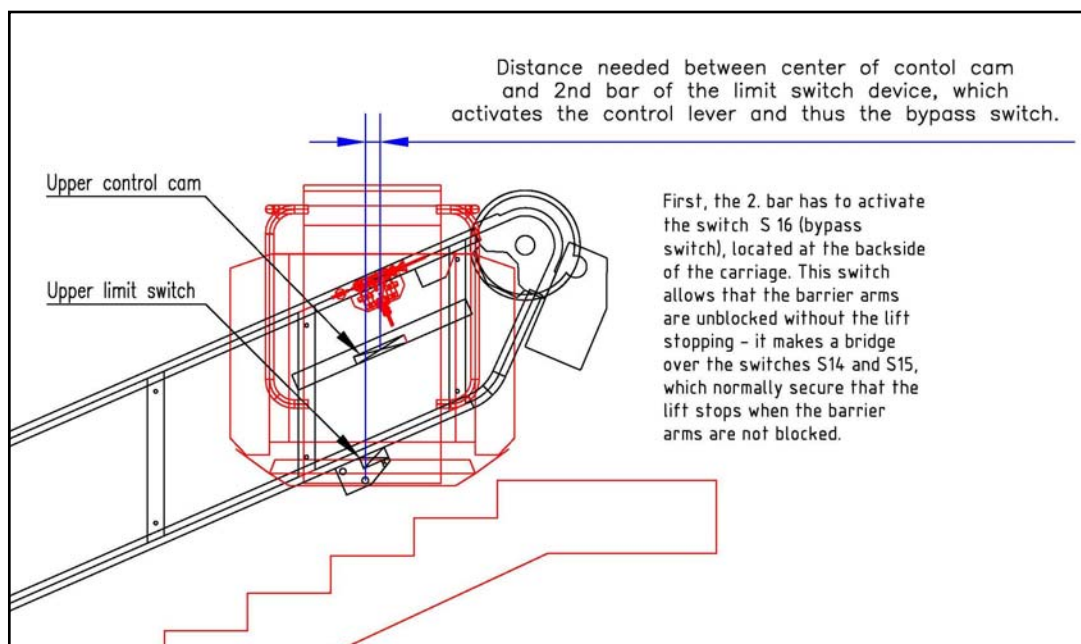

- The bypass switch S 16 makes an electrical bridge on the barrier arms safety switches S14 and S15 and therefore allows that the lift remains in function although the barrier arms are mechanically unblocked and electrical safety circuit is interrupted. S16 has to be activated before the control cams start to unblock the barrier arms in each landing station. Otherwise the lift will stop when the barrier arms are unblocked, as thus the barrier arm safety switches S14 and/or S15 are pushed and the safety circuit is interrupted!
- In the upper stop position (and also intermediate stop positions) the platform floor should be at the same level as the landings.
- On the lower landing the carriage should touch down slightly on the bottom with both buffers located on the lower end of the backside of the carriage.
- Run the carriage out of the landings and back again. If the lift does not stop in the correct position, adjust it as necessary.

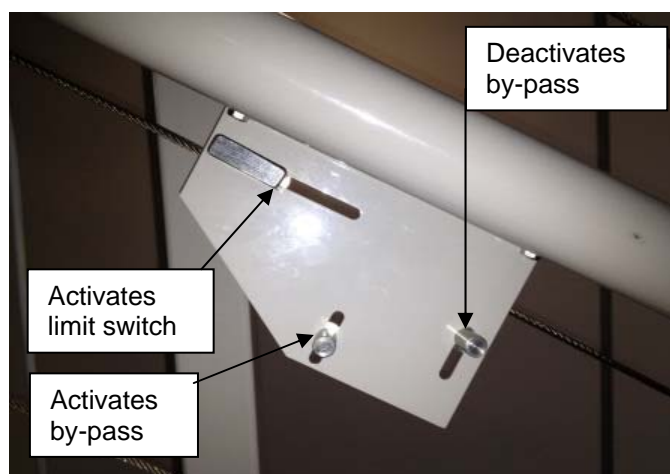
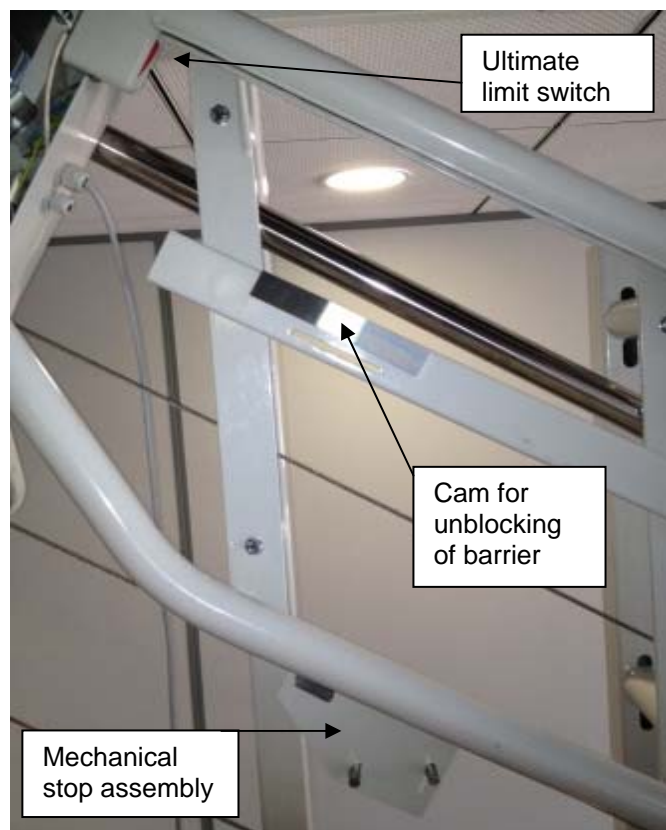

- Adjust the ultimate limit switch so that it is properly aligned with the activation pin on the cover of the upper carriage. The pin should reach the switch in case the normal limit switch does not work.

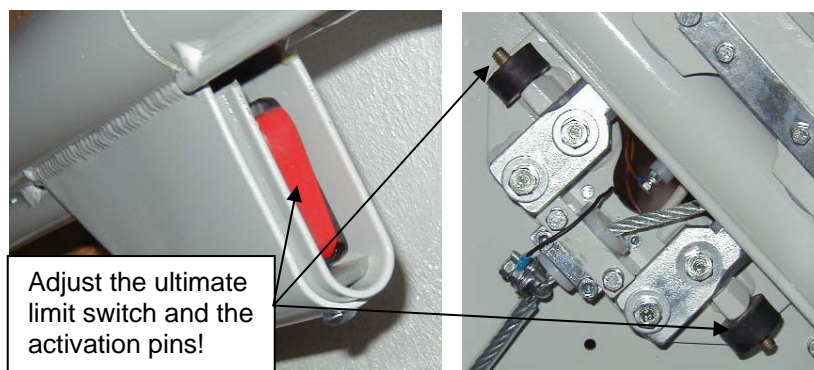

Step 8: Adjustment of the loading ramps

Be sure the control cams on the railway and all limit switches are adjusted before looking for the ramps.

Adjust the ramps to achieve a **45 ° angle** between the platform and ramp when the barrier is in horizontal position. When the barrier is open, the ramp has to fit to the bottom of the landing area. Also fix the ring at an **angle of around 45°** to the side of the ramp and at a distance of around 2/3 inside the slot. This ensures best operation.

Check the loading ramps for proper operation. In folded and unfolded position of the platform, the ramps are also used as safety pads. When fixing the ramp ensure that it still can be pushed in order to activate the safety switches S12 and S13.

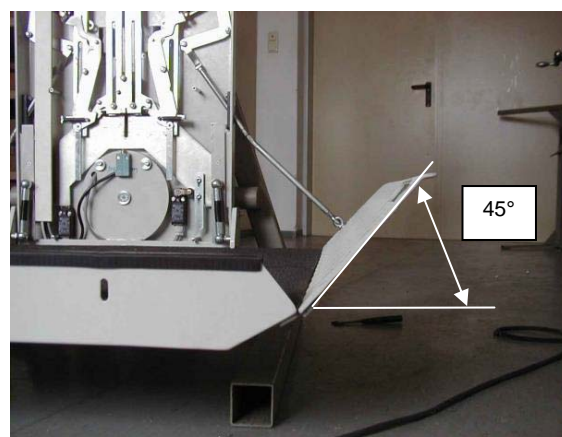
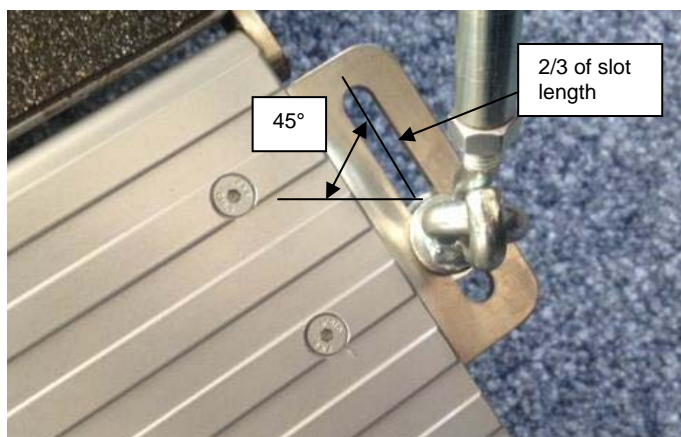

Check the loading ramps for proper operation.

Note: Remember to check travel clearances of the carriage. Do not let the unit run past the upper limit position.

Step 9: Programming the unit

The menu can be used for parameterization, maintenance and fault finding. There are 2 forms of the menu, the extended and the standard menu. The extended menu is used for programming and adjustments during installation. The standard menu is for use during general operation of the unit and allows minor parameter adjustment and fault finding. The switch S1 on the platform control board activates the standard or the extended menu.

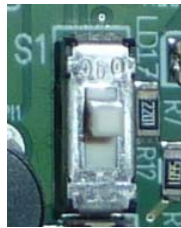

Position Standard Menu	Position Extended Menu
	

Menu item	Std. menu	Ext. Menu	Description
Language	X	X	Menu language can be selected
Serial Number	X	X	Serial number can be read
Errors	X	X	The last 20 errors that occurred can be read and the lift of errors can be deleted.
Acknowledge errors		X	This function allows acknowledging an error and thus setting the unit into function again in the landings
Operation time	X	X	The operating hours of the unit can be read and reset.
Alert output		X	Allows adjustment of the used alert outputs and their frequency.
Radio version		X	Allows the selection of the used radio control version.
Motor config.		X	Allows the adjustment of the motor control parameters including the different drive speed frequencies.
Options		X	Allows to programme special functions of the lift
Teach-in start		X	This start the teach modus for the different drive speed. This can only be started in the lower landing station.
Current pos	x	x	Read current position of encoder

Explanation of the menu

To enter the menu, both the up and the down directional button on the handset need to be pressed for more than 5 seconds. The display then shows always 2 menu items. The upper item in the display is always the active one. With the upward directional button it can be changed between the main items. With the downward (enter) button an item directory can be entered. A parameter value can be changed with the upward directional button and then be confirmed with the downward button on the handset.

Generally all functions are set according to the order specifications. The only item that has to be adjusted on site is the change of drive speed in the menu item "Teach-in Start". Below all items are explained in greater detail. The standard parameter is hereby underlined.

Language

If the predefined language is not wanted please first adjust the required menu language.

Menu item	Parameter	Meaning	Description
Language	GER	German	Language to be chosen
	<u>ENG</u>	<u>English</u>	
	CZE	Czech	
	ESP	Spanish	
	FRA	French	

Error

20 different errors can be determined and read.

Menu item	Parameter	Meaning	Description
Error list	-	-	This shows a list of the error that occurred.
Clear errors	-	-	Deletes list of errors

Acknowledge error

With this function the present failure will be deleted and the function of the lift will be restored if the error was eliminated. Errors can only be acknowledged when the platform is in a landing station. This can be done either by the use of the menu item "acknowledgement of errors" or with the button S1 on the drive unit control.

If an error can not be acknowledged it means that the error is still persisting. For example if the thermostat relay of the motor is active the error can only be acknowledged when the motor cooled down and the relay is released. The errors with light blue background in the error table above are automatically acknowledged in a landing station!

If the 7 segment display is still blinking and the display still shows an error message then the error is still persistent and cannot be acknowledged.

Operation time

This shows how many minutes the unit was running since the last reset of operation time.

Menu item	Parameter	Meaning	Description
Show op-time	-	-	Operation time is shown
Reset op-time	-	-	Operation time is deleted Attention: This should only be done by a qualified installer/maintenance company.

Alert output

A visual signal and an acoustic buzzer output can be defined. These functions can be switched on and off and the signal frequency can be chosen.

Menu item	Parameter	Meaning	Description
Signal ON/OFF	ON	Signal ON	This parameter shows if the visual signal (on contact W1 on platform control board) is on or off during driving.
	<u>OFF</u>	<u>Signal OFF</u>	
Frequency	1...8	fast→slow	Define the frequency of the visual and audio signal. Frequency is the same for the alert signal as well as for the buzzer. 1 → Fast 8 → Slow 9 → Constant
	9	constant	
Buzzer ON/OFF	ON	Buzzer ON	Defines if audio signal is on or off during driving.
	<u>OFF</u>	<u>Buzzer OFF</u>	

Remote radio control version

2 different versions of remote controls can be defined.

Menu item	Parameter	Meaning	Description
Radio version	1	Teleradio TRX-M-SOR	Defines version of radio control system
	<u>2</u>	<u>Schmidiger T60-RX-WEI</u>	

Motor configuration

The drive unit control board supports 3 different ways to control the motor. The type of control has to be defined in the menu.

The standard control used is type 3 with an inverter. In this case the frequencies for the different driving speeds can be defined in this menu.

Menu item	Parameter	Meaning	Description
Control type	1	Main contactor control	The contactors K1, K2 and K11 will be controlled via the contact X4. This control type works without a FI.
	2	Inverter 1 out of n	The FI is controlled via the contacts XRF, XAUF, XAB, XV1 and XV2. The frequencies cannot be defined in the menu but need to be adjusted directly at the FI.
	<u>3</u>	<u>Inverter with Modbus</u>	The FI is controlled via serial data network cable. The frequencies have to be defined in the menu.
FI Model	1	Schneider Ativar V12	Defines the inverter type used. <i>INFO: Is only possible when choosing parameter 3 in the control type menu item</i>
	<u>2</u>	<u>Yaskawa V1000</u>	
FI Frequencies			
Station run-in	10...25	Hz	Speed when driving in and out of a stop position. <i>INFO: Is only possible when choosing parameter 3 in the control type menu item</i>
Curves	10...50	Hz	Speed in curves or changes in gradient. <i>INFO: Is only possible when choosing parameter 3 in the control type menu item</i>
Drive	10...100	Hz	Speed on completely straight runs <i>INFO: Is only possible when choosing parameter 3 in the control type menu item.</i>

Menu item	Parameter	Meaning	Description
Impulse ON/OFF	<u>ON</u>	<u>Impulse ON</u>	<p>In order to use different speeds along the driveway the impulse control must be activated in the menu. Two impulse generators are connected to the drive unit control.</p> <p>ON means the drive way is measured and the impulses counted.</p> <p>INFO: If the impulse controls is OFF then the drive frequency for straight runs will be used on all runway!! Is only possible when choosing parameter 3 in the control type menu item.</p>
	OFF	Impulse OFF	
Pulse ratio	15...100 <u>80</u>		<p>Defines transmission from the motor shaft to the sprocket.</p> <p>See Attachment C.</p>
Fan t-overrun	1...9 <u>2</u>	seconds	Defines overrun of the ventilator
Relay NO/NC	<u>NC</u>	<u>Normally closed</u>	Type of contactor which is defined for main contactor control feedback.
	NO	Normally open	

Options

Menu item	Parameter	Meaning	Description
Opening behaviour	ON	Special folding modus	If this is ON the security circuit on the drive unit will be checked. If this is open the unit also will not fold.
	<u>OFF</u>	<u>Standard folding modus</u>	
Auto-close	ON	Automatic closing ON	If this parameter is ON then the platform will close automatically after a defined time if left open in a landing station. <i>Attention: Only possible for automatic and not for manual platforms</i>
	<u>OFF</u>	<u>Automatic closing OFF</u>	
Auto-close time	seconds	Time to fold automatically	Defines time lag for auto-fold
Middle time	Second	Time of middle stop	Time that allows for releasing and pressing again of direction button to continue driving out of intermediate landing
Call open	ON	Call and send the platform when open	If this parameter is on then the open platform can be call and sent by the external hall call stations (when transporting goods) <i>Attention: This option can only be chosen if the entire driveway of the platform is totally visible from the hall call stations.</i>
	<u>OFF</u>	<u>Not permitted</u>	
S Error behav	<u>Value 1...3</u>		Automatic reset of short circuit error 14 and 15 in landing station
Adv error reset	<u>ON</u>	Reset of error	Automatic reset of tolerance error 1, 6, 7, 8, 14 and 15 in landing station
	OFF		Error needs to be acknowledged
Parkstop	ON / OFF		Set start stop ON to programme
Parkstop start			Start of parkstop drive (for example upper landing stop)
Parkstop stop			Stop of drive (park position)
Parkstop closed	ON / OFF		Allows only to drive closed into park stop

Programming the drive speeds - Teach-in mode

To start the teach drive the platform has to be in the lower landing station. Now the menu point „Teach-in start“ can be activated and the LCD display will show the following:

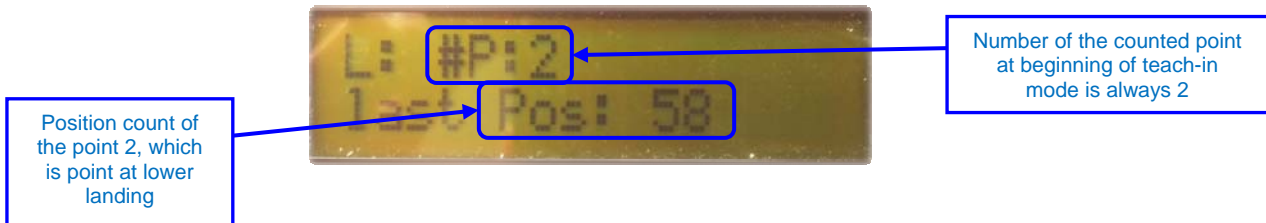

At the beginning of the teach-in start 2 points are already saved. The point #P:2 is the actual point of the lower landing stop. A virtual point #P:1 is required for the counting of the encoder but does not need to be saved nor to be changed at any time.

Once the teach-in starts the lower landing position is already saved and does not need to be confirmed with the alarm button. Now the unit can be run up with the platform control buttons to the next point where the platform speed should change.

Important: If a curve is located close to a landing station then there is no need to change the speed between the curve and the station. The lift will run with curve speed from the landing station into the curve. Therefore the first point to programme will be after the curve where the lift should start to drive fast.

The platform will drive out of the landing station with the reduced speed defined by the curve frequency in the menu. This is set by default to 25Hz. On the first point where the platform should change the speed it will then switch to drive speed, which is normally set to 50Hz.

To programme a point the lift has to run to the required point and stop. Then the point is saved by pressing 1 time the alarm button on the platform. Then the platform can drive to the next point to programme.

The following points on the driveway have to be programmed:

- Point after the lower landing station after which the platform should drive fast. This point should be located around 150mm after the lower landing station.
- Points before and after a curve, a sharp change in gradient or entry into horizontal drive. (The acceleration and deceleration curve of the FI has to be considered)
- Point before an intermediate landing stop where the platform should start to drive slowly.
- Intermediate landing stop (platform stops automatically in this point)
- Point after the intermediate landing stop where the platform should start to drive fast again.
- Point before the upper landing stop where platform should start to drive slowly.

Important: The drive speed has to be reduced before each curve, sharp change in gradient and entry/exit into a horizontal drive. The speed must be reduced before the stabilizing ball enters into the horizontal stabilizing pipe!

If a point was actually saved it can be seen on the display. There the actual saved point number and position count should be shown. The figure below shows the point 3, which actually is the first point to be saved when driving out of the lower landing station.



If an intermediate landing station is saved then after the confirmation with the alarm button a M will be shown beside the point number – see illustration below.:



The point in the
intermediate landing
station was saved

If the platform is in the upper landing station and the last point was saved by pressing the alarm button it is necessary to stop the teach-in process. This has to be done in the main menu with the menu item: "teach-in stop". If this item is confirmed with the downward directional button the programming on the points is complete and the unit can be run down to test the changing of the speeds in the saved points.

If there is a problem with the teach-in process and a point cannot be saved then one of the following error messages will show on the display:

Display	Description
invalid interval	The platform always has to drive with curve speed (slow speed) into a landing station. Otherwise this error will show.
point too close	The distance between 2 points is too close. It is important to keep a minimum distance of 150mm between 2 points.
invalid teach in	At the end of the teach-in drive the relations of the saved points are checked. If they are invalid this error will show.
rail too long	If this error is shown the total length of the rail is too long. Please contact the supplier.
too many points	A maximum of 40 points can be saved. This number cannot be exceeded.

In case of such an error the teach-in process cannot be continued. It is necessary to drive down to the lower landing station and start the whole process again by activating the teach-in start item in the main menu!

If on the display a failure code can be seen please check in the error code list for what the problem can be. This failure codes are not related to the teach-in process.



Error code 10 shown
on display

Error list and explanation

If during the operation of the lift an error is occurring, it will be displayed as an error code on the 7 segment display on the control boards as well as on the LCD display.

In the following table all error codes are listed. The error code is shown on the LCD display. If the number on the 7-segment display on the control boards is blinking it also refers to an error. The respective number or letter is shown in the brackets (x) next to the error code number in the table below.

An error can be acknowledged by the Display menu, via the button S1 on the platform control or by switching the main power supply on and off.

Name	Number	Reaction	Possible reason
No error	0 (-)	-	-
Impulse Timeout	1 (1)	Only slow drive possible	Timeout Impulse. During driving no impulses have been counted. Reasons: Encoder defect, cable not connected, FI does not start
Wrong Impulse during stand-still	2 (2)	Only slow drive possible	Impulses are counted although the lift should not have moved. Reasons: Defect motor brake; lift has moved without a drive command
KKS1 contact welded/is stuck	3 (3)	-	The relay KKS1 needs to be changed.
Too many points	4 (4)	Only slow drive possible	During teach-in mode too many points have been saved. A maximum of 40 points is possible.
Impulses outside correct values	5 (5)	Only slow drive is possible	If the counted impulses differ too much from the saved impulses.
Wrong impulses in landing station area	6 (6)	Only slow drive possible	If the counted impulses in the landing stations differ too much from the saved impulses. A possible reason can be that the stop assembly in the landing stations has been moved after the teach-in mode.

Name	Number	Reaction	Possible reason
Wrong impulses in intermediate landing station area	7 (7)	Only slow drive possible	If the counted impulses in the landing stations differ too much from the saved impulses. A possible reason can be that the stop assembly in the intermediate landing stations has been moved after the teach-in mode.
Wrong impulse on limit switch	8 (8)	Only slow drive possible	If too many impulses are counted while a limit switch is still pressed. This can be a signal that a limit switch contact did not close after the unit left the landing station.
Power cut off on runway	9 (9)	Only slow drive possible	If the platform is on the runway (outside of landing stations) and a power cut occurs then the unit cannot detect its position on the rail. The platform then has to be driven in slow drive mode into the next landing station were the failure will automatically reset.
Wrong rotation direction of motor	10 (A)	Only slow drive possible	If the encoder detects a different rotation directions than the inverter produces. Solution: Interchange contacts IMP1 and IMP2 on drive unit control board
Brake is weak	11 (b)	Only slow drive possible	If the drive is stopped and the encoder still detects a certain amount of impulses it is an indication that the brake does not stop the lift correctly.
Overload	12 (C)	Drive only till the next landing station, then stop	If the platform is overloaded and the overload switch SU gives a signal to the controller.
Motor temperature	13 (d)	Drive only till the next landing station, then stop	The thermostat relay in the motor was activated.
Short circuit between the tension rope and the rail	14 (E)	Drive only till the next landing station if short cut does not last, then stop	If there is a short circuit between the tension rope and the rail

Name	Number	Reaction	Possible reason
Short circuit between the support rope and the rail	15 (F)	Drive only till the next landing station, then stop	If there is a short circuit between the support rope and the rail
SPI Timeout on drive unit	16 (1.)	Drive is stopped	The communication between the PIC microcontroller and the Echelon Powerline module was defunct or not correctly adjusted.
Safety circuit	17 (2.)	-	Safety circuit relays (KAUF, KAB) on the platform are not released.
FI-communication	18 (3.)	Only slow drive possible	The communication with the frequency inverter via the RS485 Modbus interface did not work.
Communication with EEPROM on drive unit	19 (4.)	-	The communication between the micro controller and the EEPROM on the drive unit did not work.
Feedback from main contactors	20 (5.)	Drive only till the next landing station, then stop	One of the main drive contactors or the safety circuit relay KSK has not been released after the platform stopped driving.
Data transfer between the drive unit and the platform control	21 (6.)	Drive is stopped	The communication via the tension rope did not work correctly. This failure is detected on the drive unit.
WDTO drive unit	22 (7.)	Drive is stopped	Contact Lehner Liftechnik
SWT drive unit	23 (8.)	Drive is stopped	Contact Lehner Liftechnik
Power cut for short time	24 (9.)	Drive is still possible	Reset error in landing station.
Internal FU error	25 (A.)	Drive is stopped	Check error code on inverter
FU Overcurrent	26 (B.)	Drive is stopped	Check motor wiring for short circuit
SPI Timeout Platform	112 (-)	Drive is stopped	The communication between the PIC micro controller and the Echelon Powerline module was not correct. The Powerline module is defect or not correctly plugged.

Name	Number	Reaction	Possible reason
Data transfer between the drive unit and the platform control	113 (-)	Drive is stopped	The communication via the tension rope did not work.
Communication with EEPROM on platform	115 (-)	Drive is stopped	The communication of the micro controller with the EEPROM on the platform control did not work.
Further failures	116-118	Drive is stopped	Contact supplier

Possible errors

If during the operation of the lift an error is occurring, it will be displayed as an error code on the 7 segment display on the control boards as well as on the LCD display. If there is no error the display shows Omega as in the picture on the left.

If a safety switch is pressed or the platform is used in a wrong way the following status report could be shown on the display – “Issue reason”:

- S11p – platform is not fully opened
- S11o – platform is not fully closed
- Contact down (downward ramp or lateral bar is pressed)
- Contact up (upward ramp or lateral bar is pressed)
- Safety bottom: Contact plate under the platform is pressed
- S. circuit p – emergency stop button or lever for barrier arm unblocking are pressed
- S. circuit d – Ultimate stop switch at upper end of rail is pressed
- S. circuit br – ultimate stop switch at lower rail end or overspeed governor switch is pressed

If the unit does not work, check on the Display what the error code is shown and see on the above list what this error means. Talk to the service technician and tell him the error code so the correct action for fixing the lift can be taken.



Final checks

After the installation, adjustment and programming is completed and the lift display shows no errors during testing of all lift functions please check again the following.

Make the following checks before handing over the unit to the client:

- ✓ Check all fastenings of the rail to the wall/pillars and pillars to the steps
- ✓ Check connections of rail parts for strength and proper alignment
- ✓ Check proper fastening of the motor box
- ✓ Ensure that the rope is tensioned properly. If it is too loose, it may short against the tube.
- ✓ The current donator and current collector system must be correctly connected to the control boards
- ✓ Check clearance of the platform to the steps and opposite walls under full load
- ✓ Check function of directional safety switches: safety bottom under pan, loading ramps, landing stop limit switches
- ✓ Check ultimate limit switches function
- ✓ Check barrier arm safety switch function
- ✓ Check proper platform position at lower stop under full load; make sure safety bottom is not pressed before lower stop limit switch is pressed and check proper alignment of loading ramps
- ✓ Check barrier arms for horizontal alignment
- ✓ Check all platform functions: Drive up and down with handset (open platform) and hall calls (closed platform), opening and closing of platform in landing stations.
- ✓ Check key switch and stop button operation
- ✓ Check proper fixing and position of all platform covers

If you encounter any problems, please refer to the detailed electrical and technical documentation in the attachment.

Emergency operation

This operation mode is only to be used by trained people such as installers and service men. This emergency operation allows the platform to be used even if safety circuits are cut and emergency switches are inactive.

Important: It is necessary that after the unit has been repaired the emergency operation mode will be disabled!

To activate the emergency operation mode it is necessary to change the Jumper J1 on the drive unit control to the emergency drive position.

Jumper J1

This jumper controls the operation modus. The following 2 jumper positions are possible. Please note that no other than these 2 positions can be active, otherwise the board can be damaged.

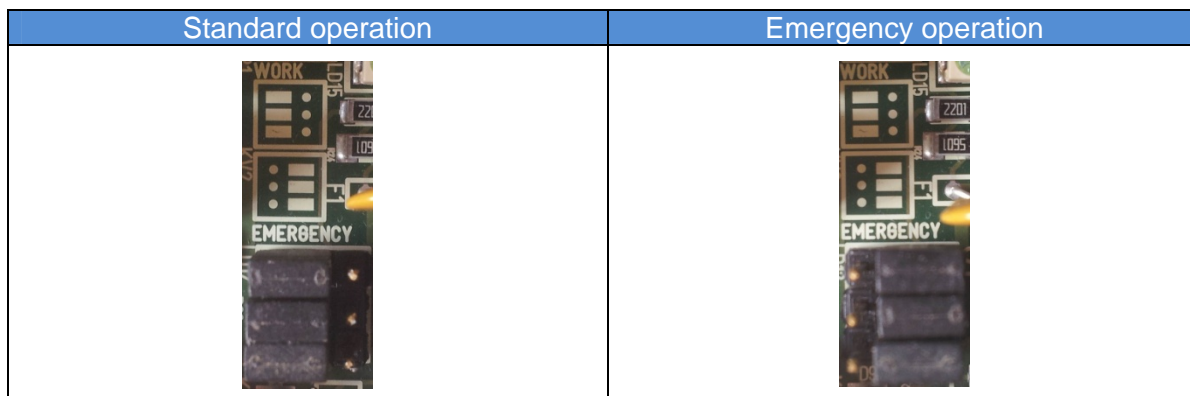

If the jumper J1 was correctly changed then the LD23 should be on. If this is on the platform can be moved. But the drive commands can only be given from the external control (radio or hard wired). At the same time as a drive command is given the button S1 has to be pressed. Both buttons have to be pressed at the same time in order to improve the security during this operation mode. On the display the error 113 will be shown when the platform control buttons are pressed.

Important: No security switches are active! The lift will continue driving as long as a drive command and S1 are pressed simultaneously.

Explanation of the electrical concept

The New Omega F system is based on the Powerline technology. Powerline communication (PLC) carries data on a conductor that is also used simultaneously for AC electric power transmission. In the case of the Omega the tension cable is used as mechanical pulling force, AC power transmission to the platform as well as a conductor for the Powerline communication.

The Omega Powerline control is a digital control, consisting of 2 control systems:

1. **Platform control board** with platform control switches located inside the platform sidewall
2. **Drive unit control board** with motor control and control switches on rail and drive unit.

The communication between these 2 control systems happens via the rope/rail system of the lift.

Characteristics:

Due to the use of programmable micro controls the characteristics on the control can easily be changed and adapt to specific circumstances needed. As the communication between the drive unit and the platform works via a digital BUS system it is possible to transfer a data packet out of 2^{64} possible ones. The secure transfer of this data is guaranteed by the use of the Powerline technology and the applied data transfer protocol.

Additionally it is possible to add an optional Ethernet module in order to allow for remote diagnosis via de internet.

Security concept:

For any drive command a double signal transfer is necessary between the 2 controls. Any drive command always needs to be processed by both control systems, thus ensuring that both systems have to be intact in order to confirm any drive command. Communication is based on the Powerline technology, using a frequency band in the area of 100 kHz for data transfer.

As a second condition for safety components such as the main contactors K1, K2 and K11, an AC voltage signal (50Hz) is required on the tension rope. The control of this signal is given by 2 independent safety relays with dropout check.

In order to allow movement of the platform 2 security conditions have to be fulfilled:

1. Communication between the controls via the rail-rope BUS system
2. Safety relays have to be active

If there is a discontinuity of the data transfer between the controls or a short circuit of the rail-rope system then the unit will stop, as in this case neither the Powerline signal nor the AC voltage signal can be transmitted.

Therefore, if 1 security system is defect the second will still be active and guarantee a safe stop of the unit in case of a failure.

Drive unit

The drive unit is located at the upper end of the rail. Its main components are:

1. Motor and gearbox
2. Drive unit control board
3. Frequency inverter
4. Main contactor control board

The following illustration shows a schematic overview of the main communication components of the drive unit.

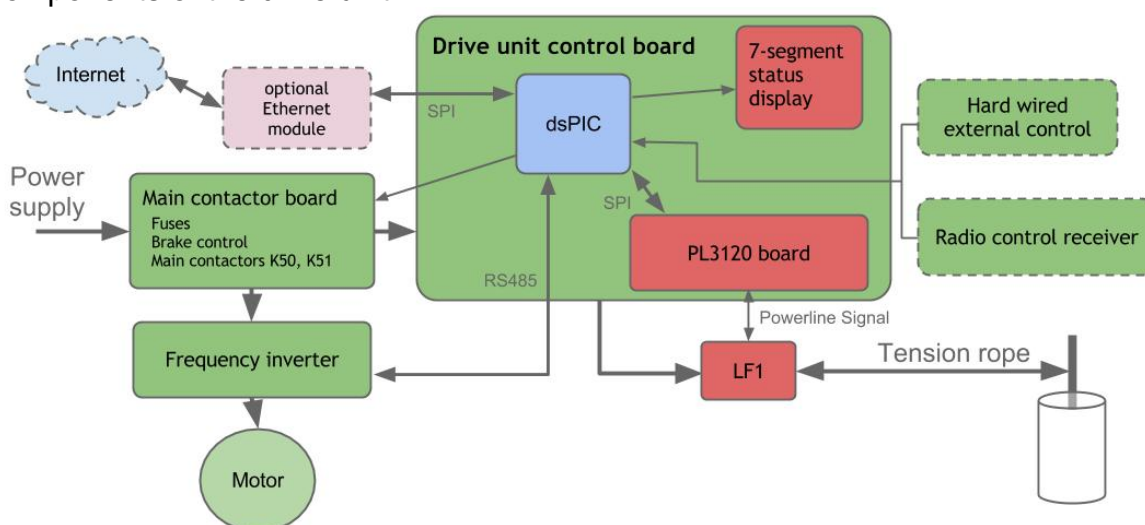

Drive unit control board

The drive unit control board takes processes all commands to run the main motor and also controls a few safety switches located on the drive unit or rail. The main components can be seen in the following picture. The drive unit control has interfaces to communicate with the platform controls via the cable-rail connection as well as to activate the frequency inverter or additional relays.

Overview of drive unit control

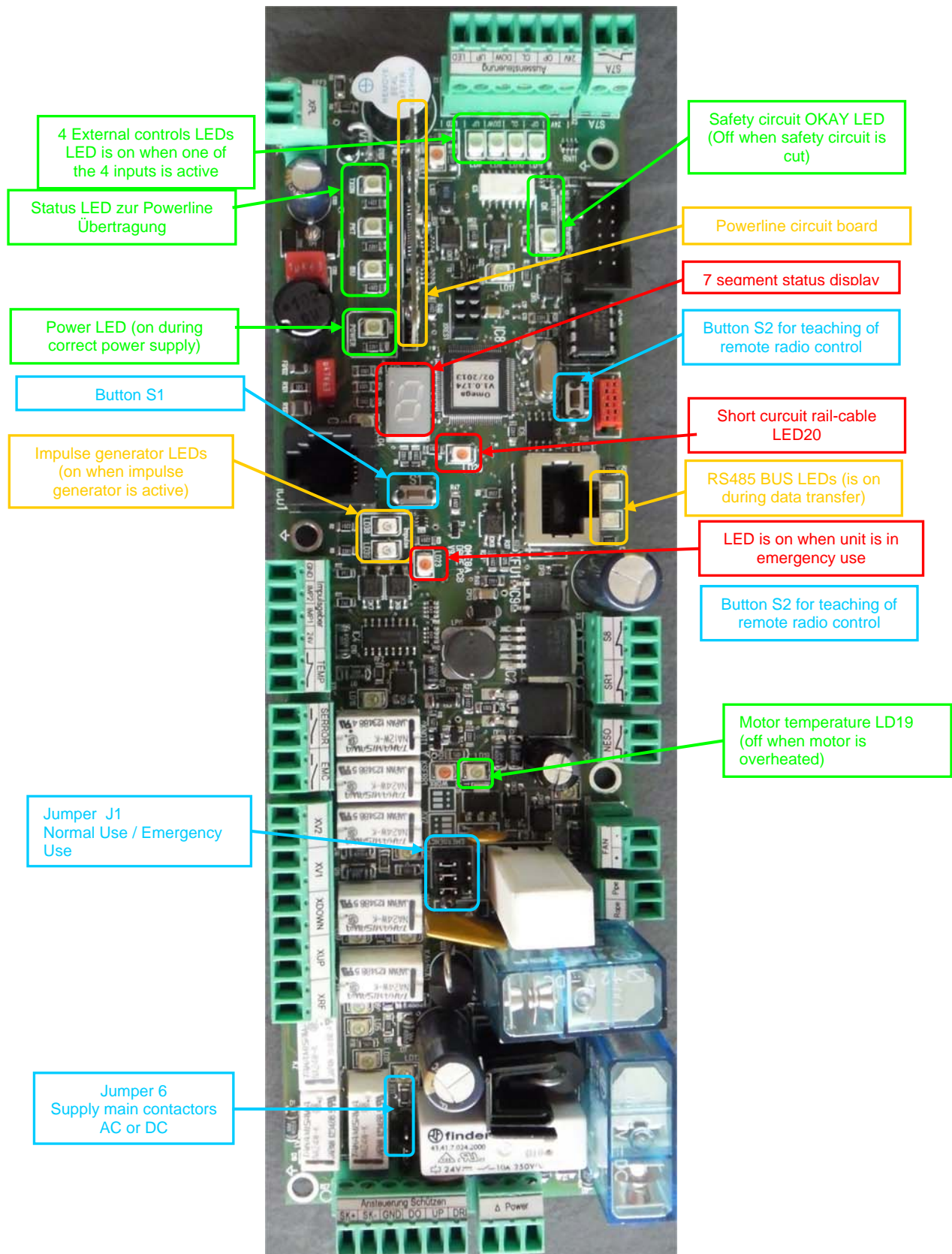

Hard wired
external controls -
optional

Emergency stop
in landing station -
optional

Modulator contact

Impulse donator 1
and 2, common and
power supply

Motor thermostat relay

Optional potential free contact for
error output – normally empty

Optional potential free contact for
emergency call – normally empty

Optional contacts
for inverter
connection
without RS485
interface –
normally empty

Inverter K11 contact

Hand wheel switch

Reserve safety circuit - bridged

Ultimate upper limit switch

Motor ventilation

Current donator for
tension rope and tube

Tension supply for main contactors
and contactor feedback

Voltage supply from transformer



Buttons and Jumpers

On the drive unit control board different buttons and jumpers are located that control different functions as listed below:

Button S1

This button has 2 different functions depending on type of operation modus:

1. Standard use (work modus): Button used to acknowledge failures indicated on display
2. Emergency use (emergency modus): As a security measure this button has to be pressed in order to be able to drive the unit in emergency use. See page 35.

Button S2

Is used to teach the radio controls senders.

Jumper J1

This jumper controls the operation modus. The following 2 jumper positions are possible. Please note that no other than these 2 positions can be active, otherwise the board can be damaged.

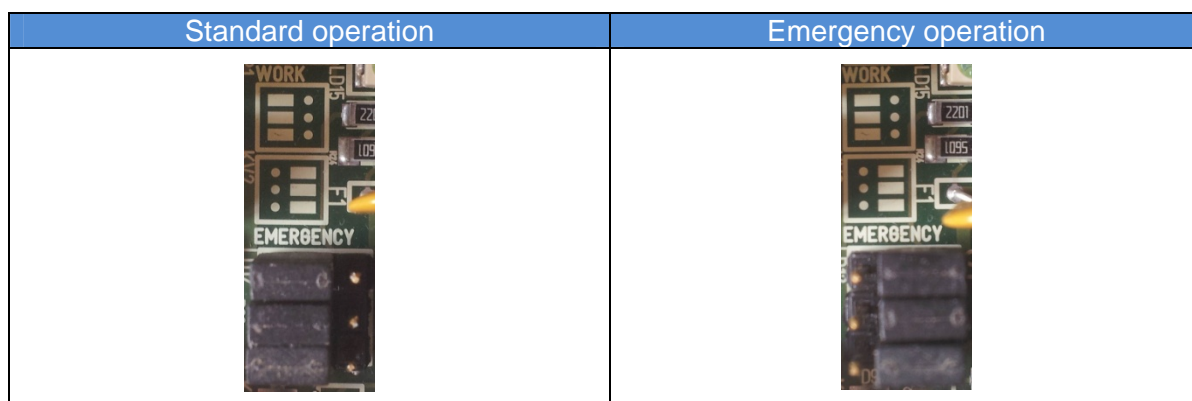

Jumper J6

With this jumper the voltage type for the main contactors can be set, depending on the type of main contactors used. Wrong jumper position can damage the board!

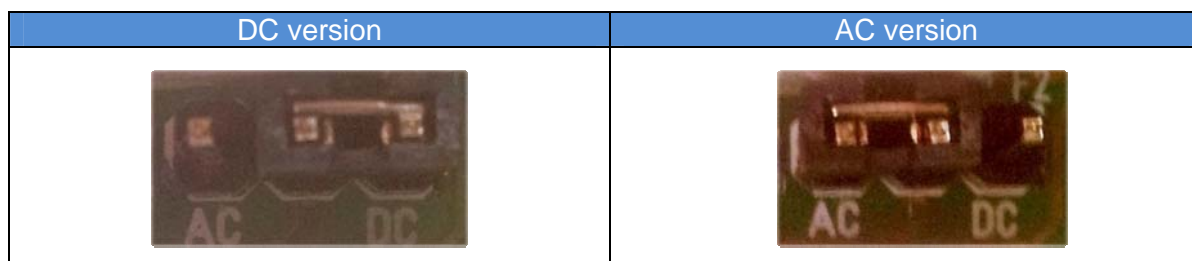

Main contactor control board (MCCB)

The main contactor control board, located in the drive box, is used for the control of a single or 3 phase inverter up to 2,2kW. With the 2 main contactors K50 and K51 both the inverter, as well as the motor brake are controlled. Details of the function are shown in the wiring diagram.

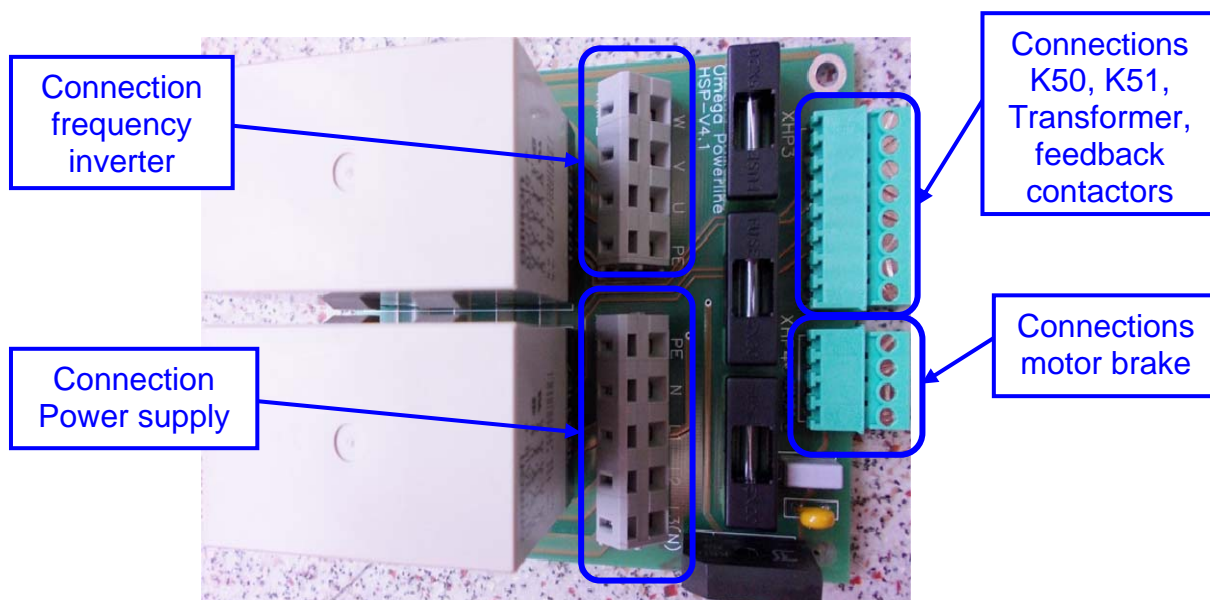

Platform control

The illustration below shows the main communications components for the platform control:

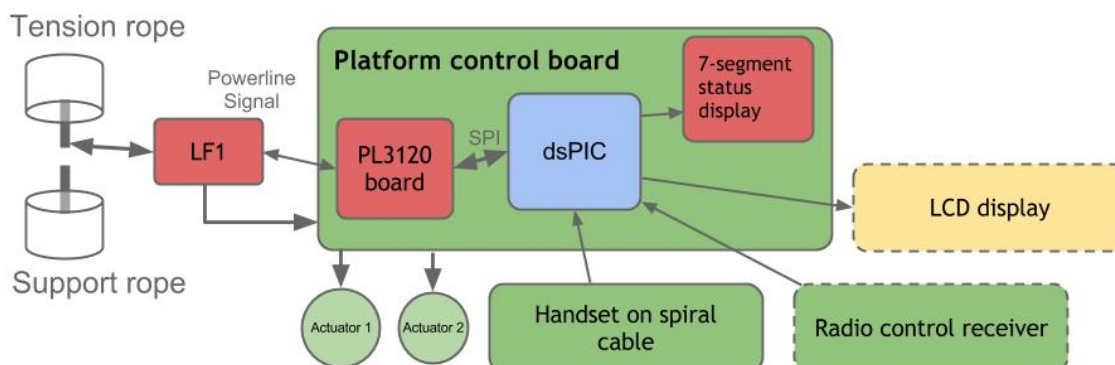

Via the tensions rope the platform is supplied with voltage and information. For the drive commands the user can use a handset or a joystick connected to the platform control. The status of the platform can be seen on the LCD display. A 7.segment display shows the current status of the unit.

The platform control has also 2 outputs to steer actuators. 1 is generally used to steer the main actuator responsible for opening and closing of the platform and barriers. A second one can be used to control a lateral access ramp.

Platform control board overview

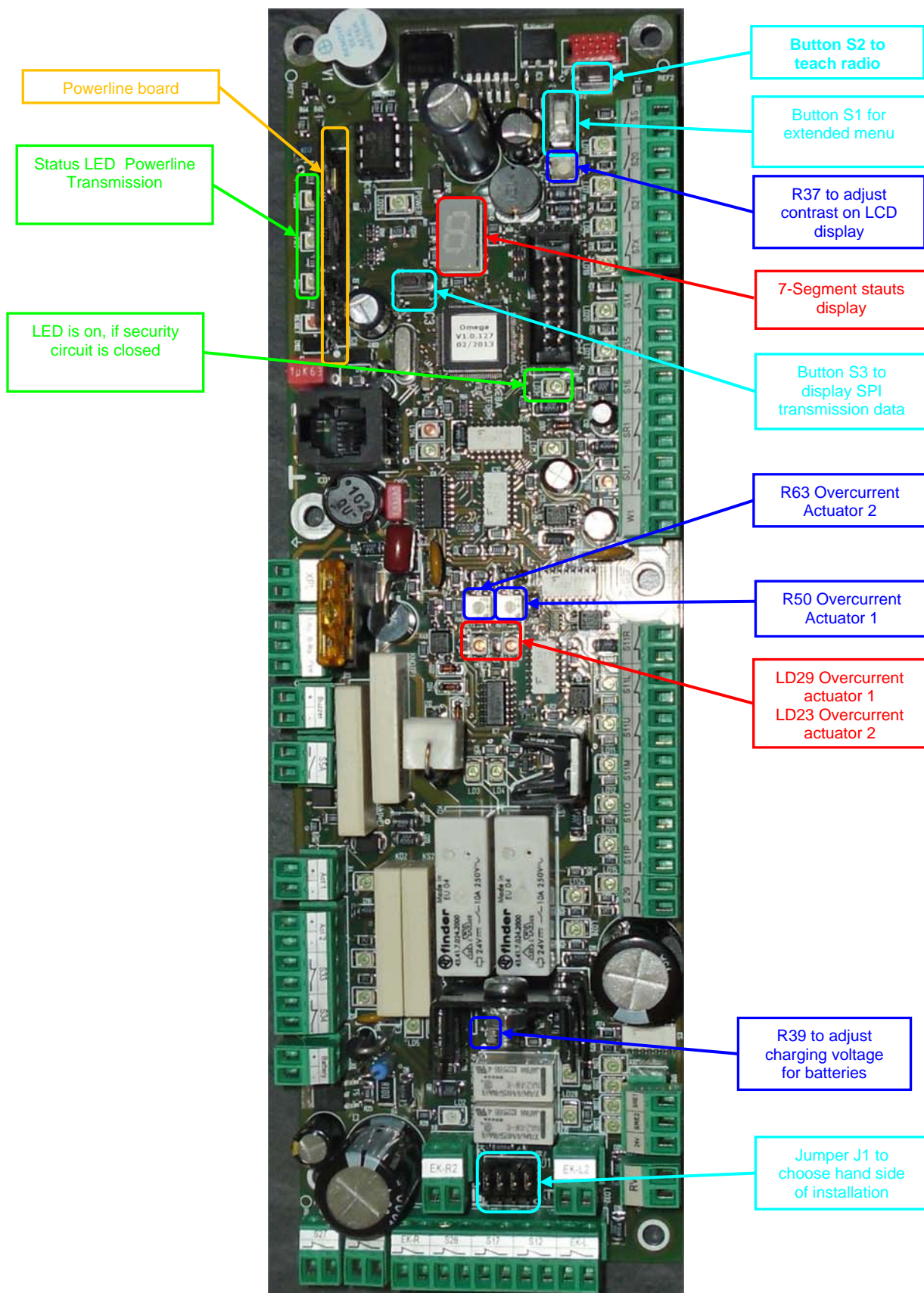

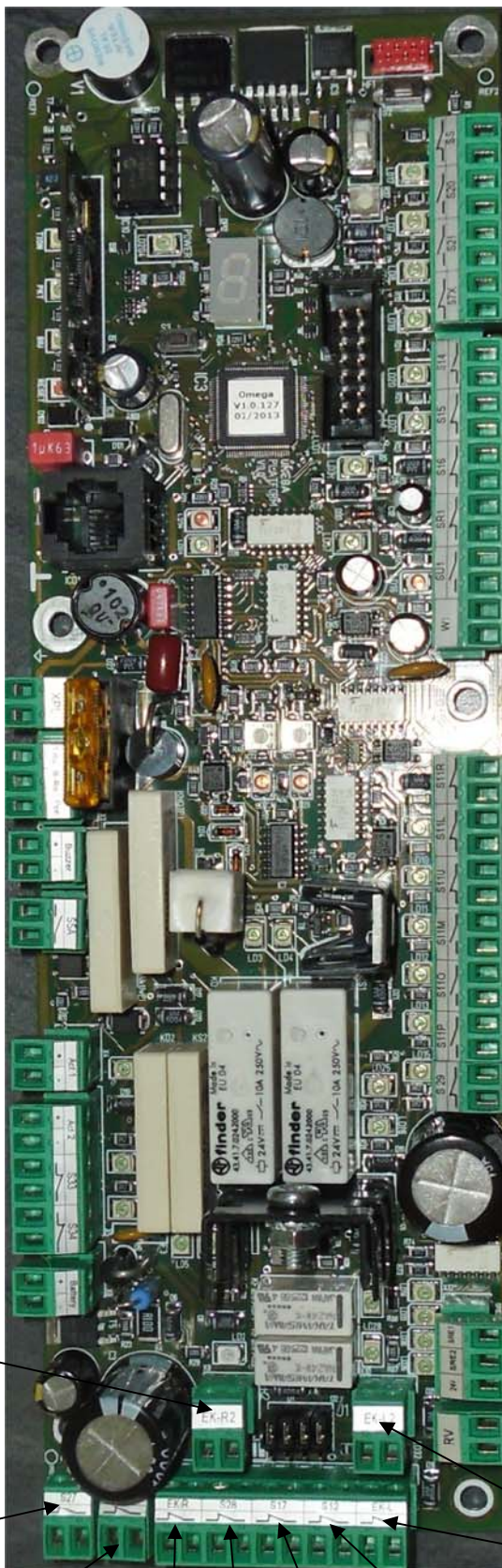

- Modulator
- Current collector connections for tension rope, support rope and tube
- Buzzer output
- Emergency call button on platform
- Power supply platform actuator
- Power supply 2nd actuator - empty
- Limit switch 2nd actuator - empty
- Limit switch 2nd actuator - empty
- Battery power supply
- Right lateral contact bars
- Upper limit switch S27
- Right ramp switch S13
- Right lateral contact bars
- Lower limit switch S28
- Key switch
- Drive up
- Drive down
- Stop button
- Barrier blocking left – switch S14
- Barrier blocking right – switch S15
- By-pass switch S16
- Reserve safety circuit - bridged
- Overload switch
- Output for visual signal – 200mA
- Right barrier control switch S11R
- Left barrier control switch S11L
- Barrier arms vertical switch S11U
- Barrier arms horizontal switch S11M
- Platform closed switch S11O
- Platform open switch S11P
- Intermediate landing stop switch S29
- Reserve contacts – normally empty
- Consumer load for safety circuit
- Left lateral contact bars
- Left lateral contact bars
- Left ramp switch S12
- Safety bottom switches S17

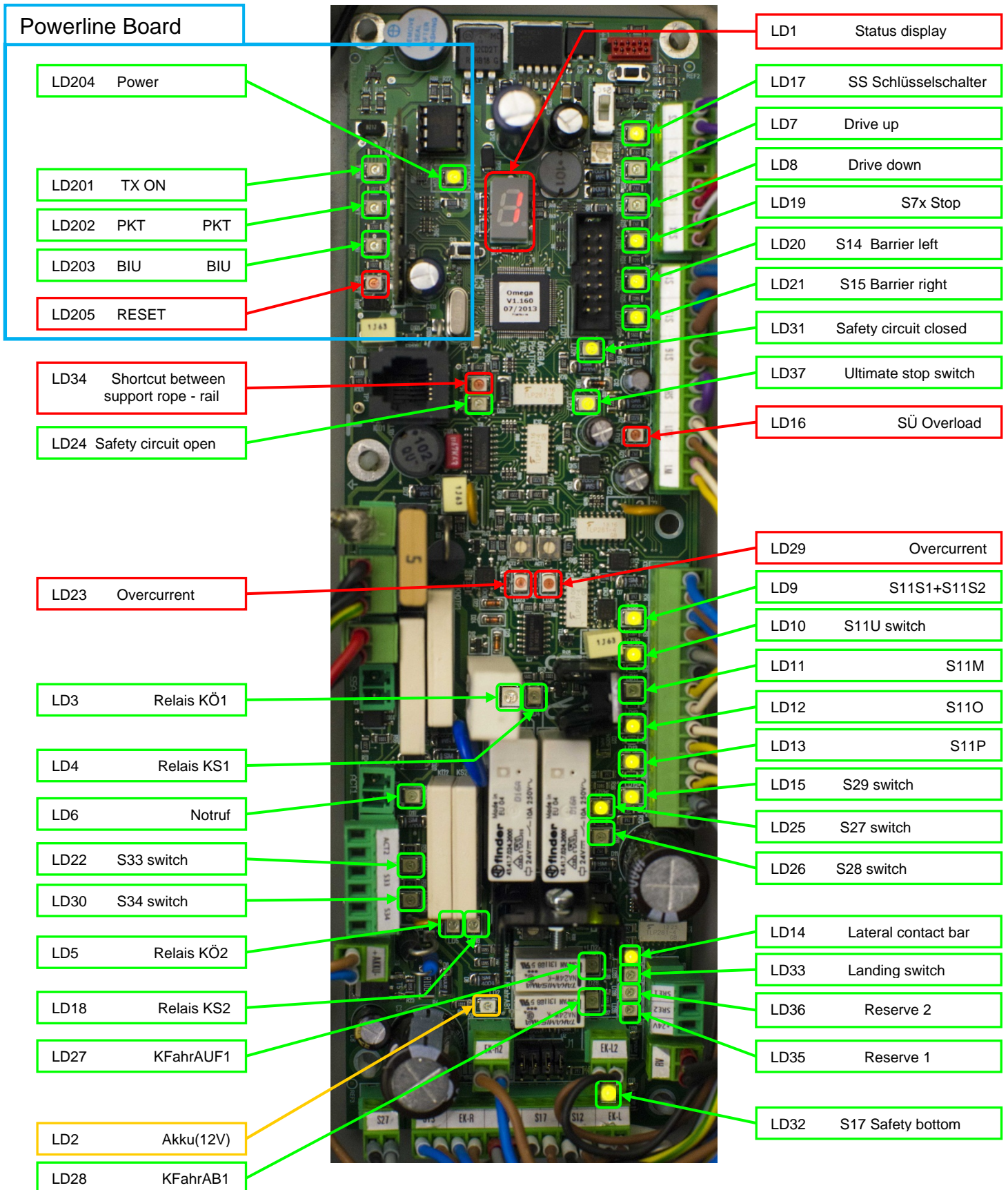

Switches, buttons and jumpers on the platform control board**Switch S1**

With this switch can be chosen between the standard and the extended menu. See page for details.

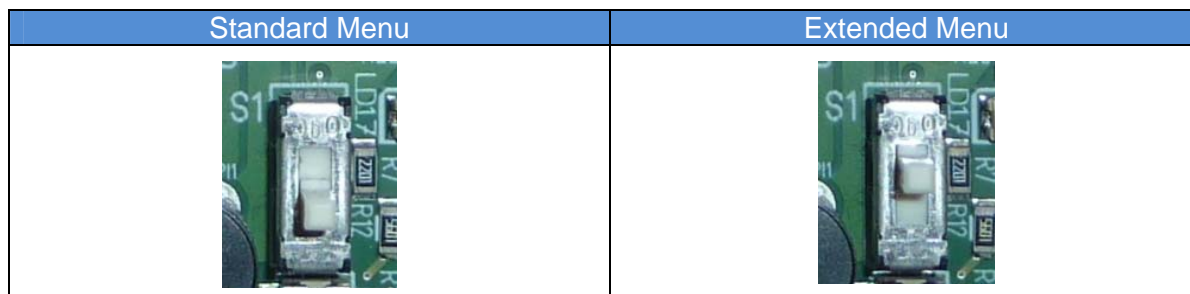
**Button S2**

With this button the radio receiver can be programmed. See page 46 for details.

Button S3

If this button is pressed then the 7 segment display does not show anymore the status but shows the SPI transmission data. This function can be used for fault finding.

Jumper J1

The position of this jumper defines the hand side of the installation. The rail can be installed on the right or left hand side, looking at the staircase from the lower level. For correct function only the following 2 position of the jumpers are possible:

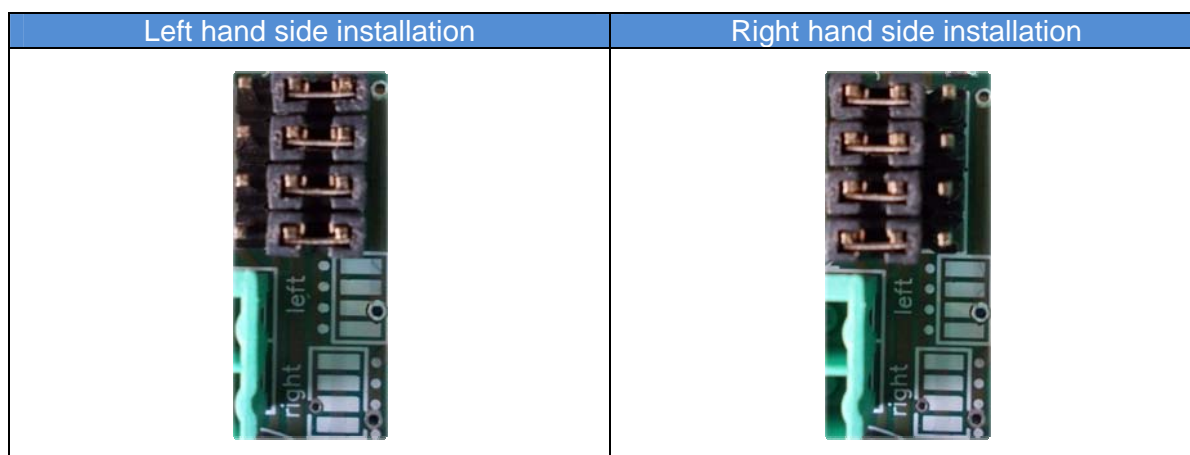

Configuration of the remote radio controls

2 different systems are offered for the Omega system. The used system has to be defined in the menu and there 2 different ways to programme the remote radio senders.

Version Schmidiger:

To programme the remotes the button S2 on the platform control board where the receiver is connected to has to be pressed until the LED on the receiver start to blink.

Now the senders can be programmed. To programme a sender the up and down button on the sender have to be pressed simultaneously. Then the LED on the sender start to blink in orange for 2,5 second and then remains on in an orange light and then green light. Now the sender is programmed. Now the next sender can be programmed in the same way by pressing the 2 buttons simultaneously.

To stop the programming mode the button S2 has to be pressed again and the action will be confirmed by the receiver by fast blinking of the LED.

The remote radio controls have different LED status indications. The below status refers to the radio control model TX-OMDE-V-01:

LED status	Description
Green light	Radio signal ok and drive command is active
Orange light	Radio signal ok and platform is not driving or folding A reason can be that the platform is driven from the platform control or that a safety circuit is open in the electrical system.
Red light	Radio signal is ok but the lift is not moved by the command.
Orange blinking	Radio signal is not ok – there is a disruption
Red blinking	The batteries of the sender a weak and should be changed
Green blinking	The sender was successfully connected to the receiver during programming

Version TeleRadio:

To programme the remotes the button S2 on the platform control board where the receiver is connected to has to be pressed for 1-6 seconds. After releasing the button S2 the receiver waits for 5 seconds that any button on the sender to programme is pressed for at least 2 seconds. After he receives the signal from the sender the receiver goes back into normal operation mode and the sender is saved. Then the next sender can be programmed in the same way.

Adjustments on the platform mechanics

Overview of the platform mechanics

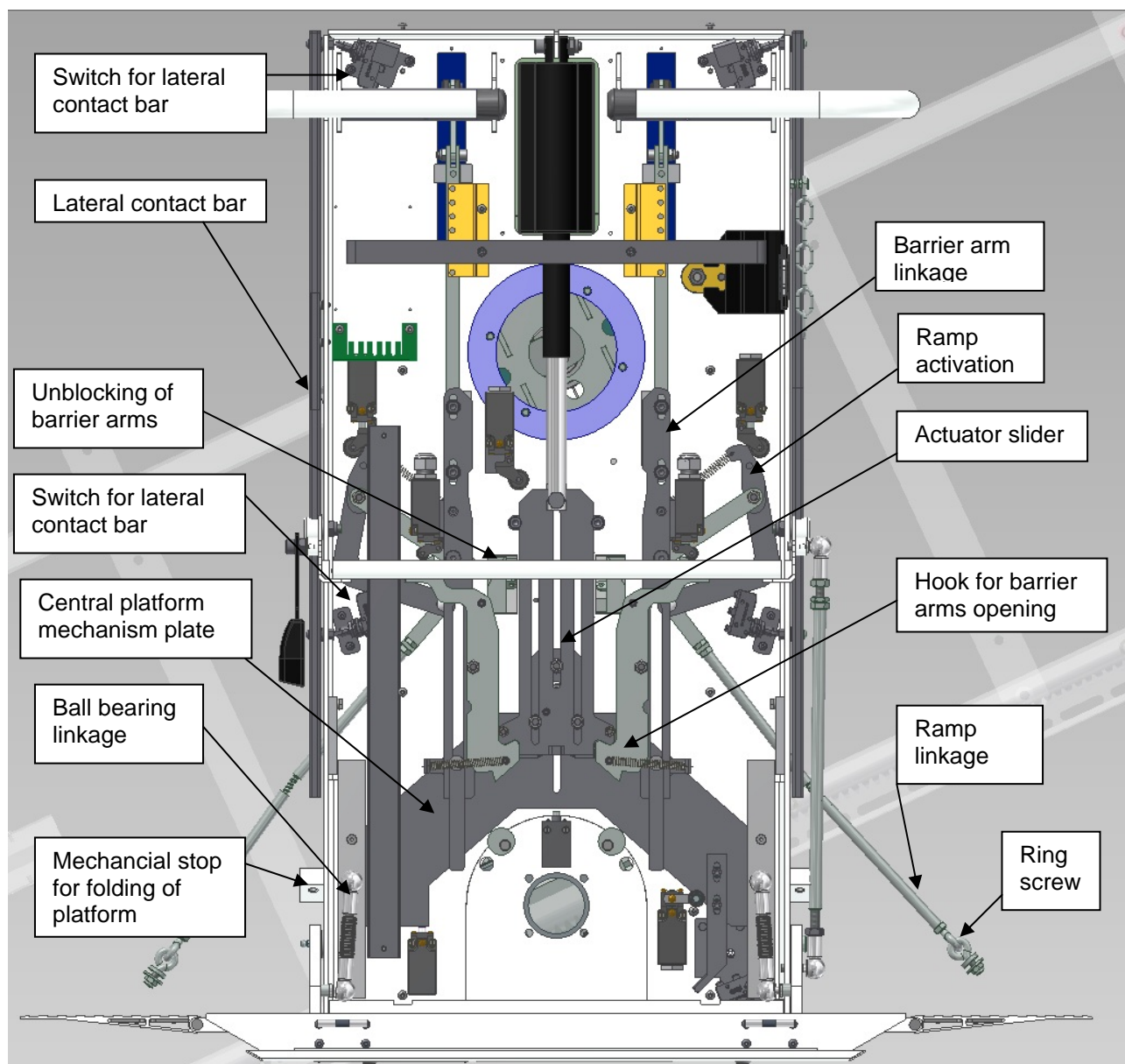

Adjustment of the platform inclination

To adjust the platform horizontally, change the adjustment screws as shown in the picture. Check in loaded condition! Counter the adjusting screw with the counter nut after successful adjustment.

Caution: Check if **both** adjusting screws are supporting the platform!

After changing the platform inclination please check the platform mechanism:

- Between the hook and the slider should be around 2mm gap. This can be adjusted by moving switch S11m.
- S11p must be properly pressed when platform is open (it must click when pressed). Otherwise adjust.
- S11o must be pressed when platform is closed. Otherwise adjust.
- Between the main bearing and the platform sliding mechanism a minimum distance of 1-2mm must be given. This can be adjusted by changing the length of the ball bearing connection between the platform and the carriage. This is important so that mechanical force of the platform in an unfolded position is not directly carried forward to the mechanical parts inside the platform, but rather held by the adjusting screws!
- If barrier arms are not horizontal open the screw shown in the illustration, adjust the barrier and lock the adjustment with the screw again.

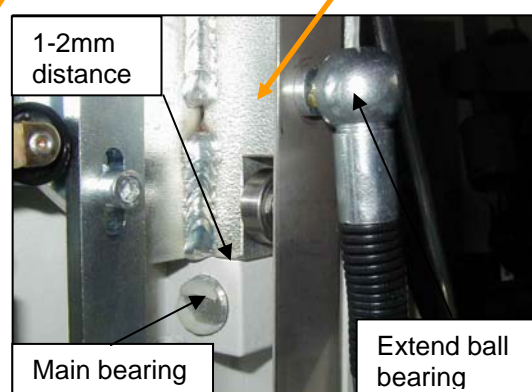
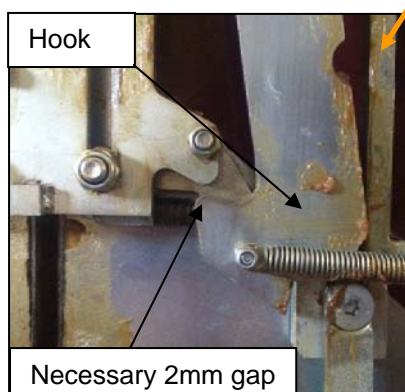
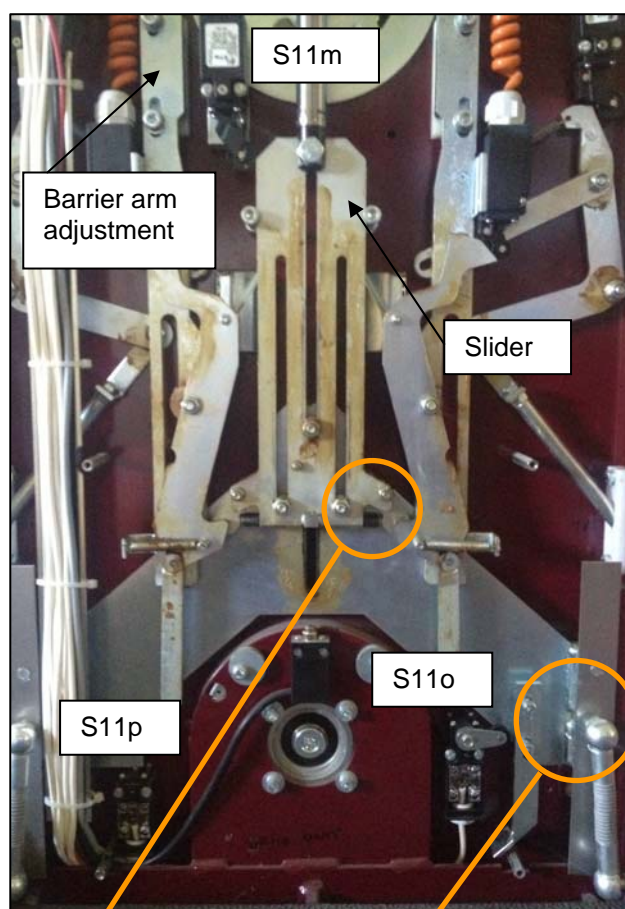
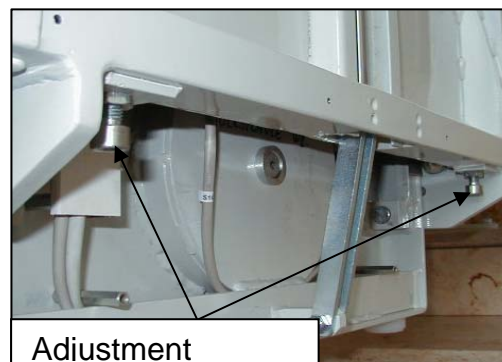

Dismantle the platform floor

- Dismantle the ball bearing connection between sliding mechanism and platform
- Disconnect platform rod connection for sidewall
- Dismantle safety under-pan of the platform
- Disconnect spring inside platform floor. You might need to manually compress the spring in order to uninstall the connection. Make sure that the connection between the spring and the bearing is correctly put together afterwards. The connection metal parts have a slight bend. It is important for reassembly that they are put back in the same way.
- Disconnect the electrical wiring between the platform floor and the sidewall
- Disconnect fixing screw from the treaded pinhole of main platform hinge bearing
- Remove the main bearing pin and take off the platform floor

