

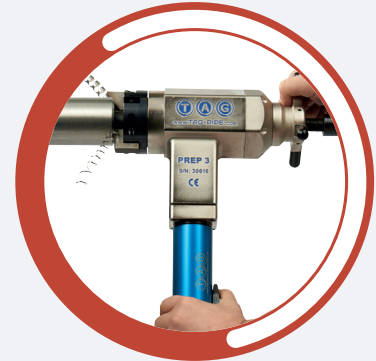

PIPE EQUIPMENT SPECIALISTS LTD

## PREP 3 PIPE BEVELLING 1" to 3"

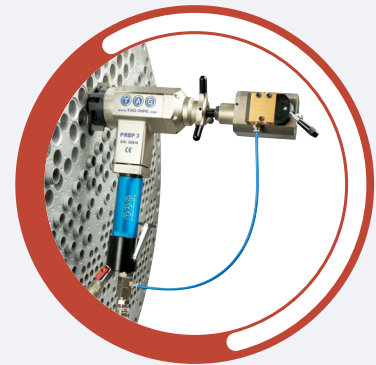

[www.TAG-PIPE.COM](http://www.TAG-PIPE.COM)

Copyright © 2017 TAG PIPE EQUIPMENT SPECIALISTS LTD. All rights reserved.

Tel: +44 (0)1869 324 144  
E-mail: [sales@tag-pipe.com](mailto:sales@tag-pipe.com)

**RANGE: 28 to 76mm i/d (Optional from 20mm i/d)**

- **Functions:** External Beveling  
Internal Beveling  
Elbow Beveling  
Facing  
Counter-boring  
Weld Removal  
J-Prepping and facing of Tubeplate
- **Materials:** Any kind of Steel  
and Exotic Alloy
- **Power:** Pneumatic / Electric / Battery  
(110v or 220v)

The PREP 3 is a popular i/d locking, in-line feed end prep machines. The PREP 3's power to weight ratio, in electric, battery (110v or 220v), or pneumatic drive form is unrivalled.

A 4 jaw tool holder (chuck) allows use of up to 4 insert or form tools to enable beveling of heavy wall pipe & tube.

Simultaneous external, internal and facing of tubes can be performed with ease for accurate repetitive work.

Its size, power, and functionality, makes it extremely popular in high volume boiler repair and maintenance work, tube facing, weld removal, and J-Prepping of the tube plates and panels.



### FEATURES & ADVANTAGES

The PREP 3 is torque reactive. This means that the pipe or tube does not have to be fixed to be bevelled, making it particularly useful on-site, in maintenance and repair situations. This is due to the design and strength of the thru shaft system that locks to the bore of the pipe.

The Jaw system itself consists of 3 equilaterally positioned machined jaw segments, retained and locked on an inner, 'grooved' expansion shaft.

These grooves keep the jaws held securely in position, unlike other systems that use a metal or rubber bands for jaw retention.

As the expansion nut is tightened, the jaws expand, locking tightly, and square to the bore of the pipe.

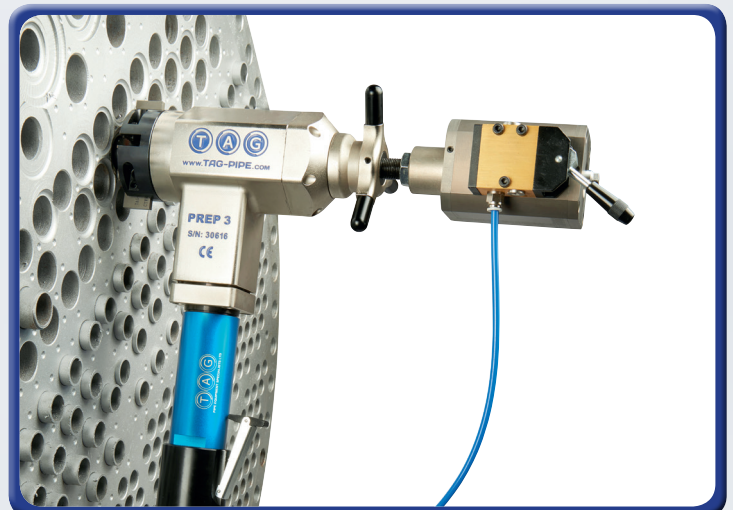
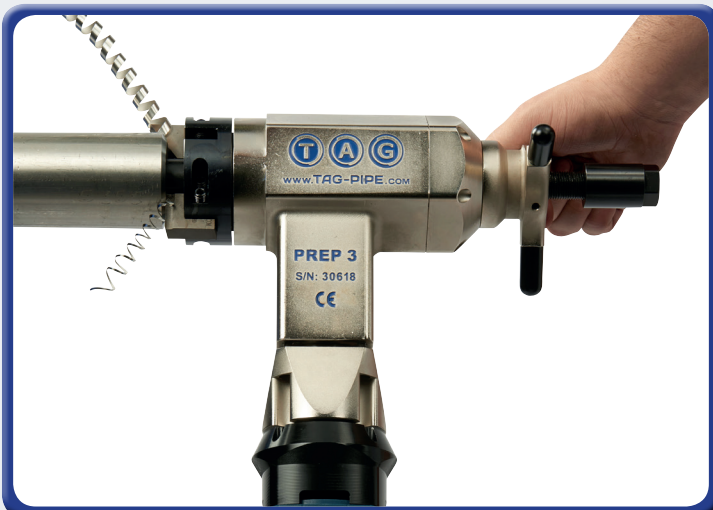

# POWER OPTIONS:

## PNEUMATIC



PART NO. TP3P

## ELECTRIC



PART NO. TP3E

## BATTERY



PART NO. TP3B

# ACCESSORIES & OPTIONS:

## REDUCED SHAFT

20 - 30mm



PART NO. TP3RSK

## ELBOW SHAFT



PART NO. TP3ESK

## AUTO LOCK



PART NO. TP3ALD

## RATCHET HANDLES



PART NO. TP3AHK

## FEED STOPPER



PART NO. TP3FSK

## FILTER LUBRICATOR



PART NO. AFL1

# PREP 3 TECHNICAL FEATURES:

DESCRIPTION	MEASUREMENT	PNEUMATIC	ELECTRIC	BATTERY
Part Number	-	TP3P	TP3E	TP3B
Locking tube range	mm (i/d.)	28 - 76	28 - 76	28 - 76
Recommended working range	inch (o/d.)	1 - 3"	1 - 3"	1 - 3"
Idle speed	rpm	0 - 120	5 - 82	55
Torque	kgm/nm	14 / 137+	19.7 / 193+	22.1 / 216+
Length of axial feed	mm	40.5	40.5	40.5
Max operating temperature	c°	55	55	55
Max acoustic radiation	dB	75	75	75
Pneumatic motor power	hp	1.4	-	-
Air consumption	cfm	34 - 36	-	-
Air working pressure	psi	20	-	-
Air hose connection	inches	½"	-	-
Electric motor power	watt	-	1300	1800
Voltage	volt	-	110 / 220	charger 110 / 220
Frequency	Hz	-	50 / 60	charger 50 / 60
Unit weight	kg	8.8	9.9	10.4
Packing dimensions	mm	640 x 500 x 140	640 x 500 x 140	640 x 500 x 140
Packing weight	kg	23	24	25

## PACKAGE

All units are supplied complete with all locking jaws to cover the full range of the machine. Service tools, drawings, instruction manual and warranty certificate and protective metal carrying case.



## DIMENSIONS

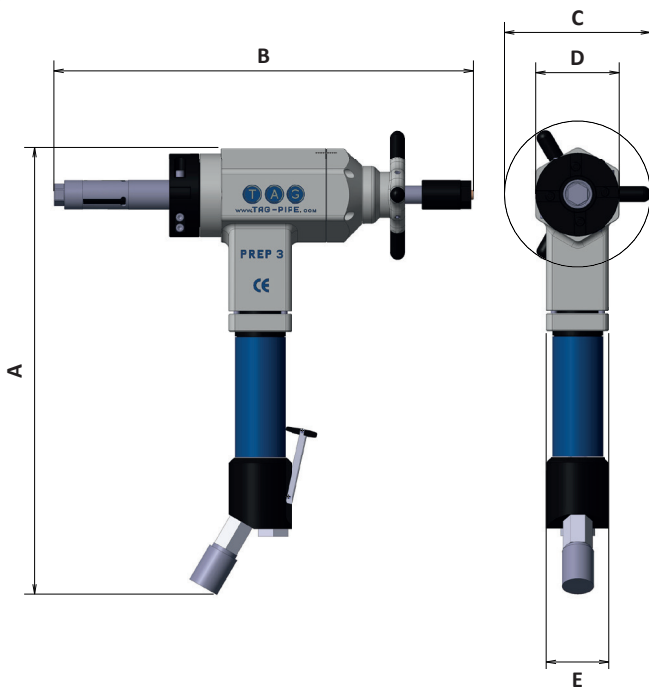

DIM	PNEUMATIC	ELECTRIC	BATTERY
A	435mm	500mm	530mm
B	402mm	402mm	402mm
C	140mm	140mm	140mm
D	80mm	80mm	80mm
E	60mm	90mm	72mm

## EXAMPLES OF COMMON CUTTING TOOLS

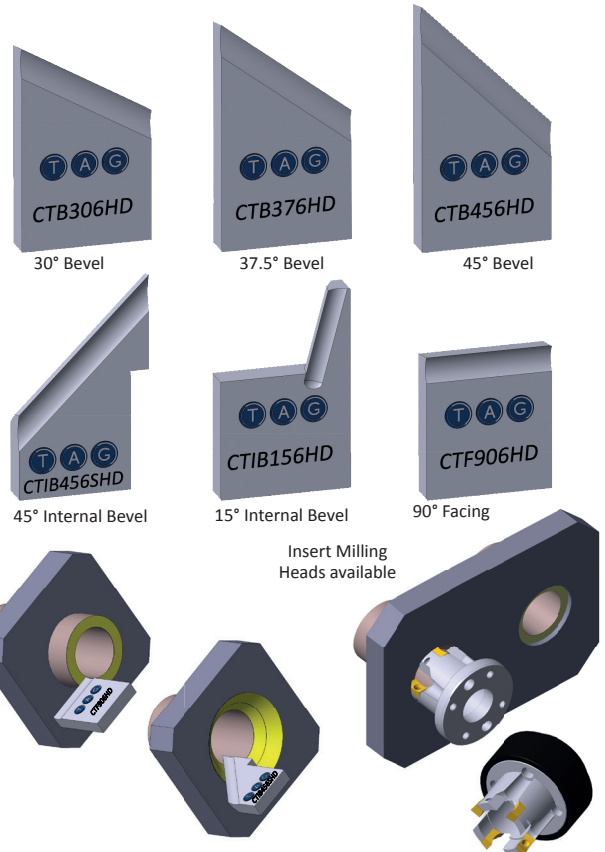

*All shapes, sizes and angles available*



# PIPE EQUIPMENT SPECIALISTS LTD PRODUCTS INCLUDE:

## PIPE BEVELLING MACHINES

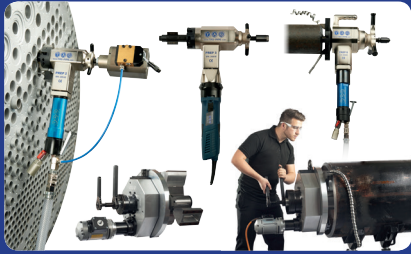

## PIPE CUTTING MACHINES



## PIPE ALIGNMENT CLAMPS

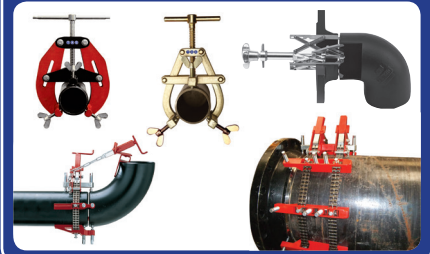

## PIPE STANDS AND ROLLERS



## PIPE PURGING EQUIPMENT



## PLATE BEVELLERS



North America

Europe

Asia

Middle East

India

Africa

South America

Australia



### TAG Head Office

**TAG PIPE EQUIPMENT SPECIALISTS LTD**  
Unit 15 & 16 Grendon Industrial Estate, Grendon Underwood,  
Aylesbury, Buckinghamshire, HP18 0QX England  
Tel: +44 (0)1869 324 144 E-mail: sales@tag-pipe.com  
[www.TAG-PIPE.com](http://www.TAG-PIPE.com)

### Your Local Distributor

## Overseas Branches



### USA Branch

TAG PIPE EQUIPMENT SPECIALISTS INC  
527 Michigan Street, South Houston  
Houston, Texas 77587, USA  
Tel: +1 713 660 1427  
E-mail: sales-usa@tag-pipe.com



### Europe Branch

TAG PIPE EQUIPMENT SPECIALISTS BVBA  
Mosten 13, 9160 Lokeren  
Belgium  
Tel: +32 486 46 62 93  
E-mail: sales-europe@tag-pipe.com



### Middle East Branch

TAG PIPE EQUIPMENT SPECIALISTS FZE  
Al Ittihad Street, P.O. Box 3763  
Dubai, United Arab Emirates  
Tel: +971 (0)50 680 3107  
E-mail: sales-me@tag-pipe.com



### India Branch

TAG PIPE EQUIPMENT SPECIALISTS PVT  
Plot No. PAP 3, D 3 Block,  
Chinchwad, Pune 411 019  
Tel: +91 20 6573 4333  
E-mail: sales-india@tag-pipe.com



### Asia Branch

TAG PIPE EQUIPMENT SPECIALISTS PTE  
Yinhe Bridge West, Beichen District  
Tianjin, China  
Tel: +86 139 2001 5417  
E-mail: sales-asia@tag-pipe.com

*Our company policy is one of continuous improvement. Products may change or vary from those illustrated.*

*Copyright © 2017 TAG PIPE EQUIPMENT SPECIALISTS LTD, All rights reserved.*